

Neutrino mass and grand unification

Goran Senjanović

August 18, 2014

Abstract

The tiny neutrino masses and the associated large lepton mixings provide an interesting puzzle and a likely window to the physics beyond the standard model. This is certainly true if neutrinos are Majorana particles, since then, unlike in the Dirac case, the standard model is not a complete theory. The Majorana case leads to lepton number violation manifested through a neutrino-less double beta decay and same sign dileptons possibly produced at colliders such as LHC. I discuss in these lectures possible theories of neutrino mass whose predictions are dictated by their structure only and this points strongly to grand unification. I cover in detail both $SU(5)$ and $SO(10)$ grand unified theories, and study the predictions of their minimal versions. I argue that the theory allows for a (moderate) optimism of probing the origin of neutrino mass in near future.

1 Foreword

The theory of neutrino masses and mixings is a rich subject, with a continuous flow of papers as you are reading these lecture notes. There is no way I could do justice to this vast field in such a short time and space so I chose to concentrate on what my taste dictated. In order to be as complete and as pedagogical as possible on the issues chosen to be discussed, I have completely omitted a popular field of horizontal symmetries which are used in order to make statements on neutrino masses and mixings, and I apologize to the workers in the field. My decision is prompted by my lack of belief in this approach which to me amounts often to a change of language.

Instead of accepting the values of these parameters one typically chooses some textures of fermion mass matrices (this is done by the use of symmetries, often discrete ones) which then lead to definite values of masses and/or mixings. The problem that I have with this approach is that to this is like

saying that proton is stable because of baryon number symmetry or that photon is massless because of gauge invariance. The symmetries we assume need not to be exact, and the departures from these symmetries will give departures from the values that follow consequently. It does not make sense to me to say that proton and neutron should have the same mass because of $SU(2)$ isospin invariance, and here I am sure the reader will agree with me. The small mass difference between the proton and the neutron only says that the isospin symmetry is quite good, albeit approximate symmetry.

In searching for the origin of neutrino mass, I have opted here to theories whose inner structure leads to neutrino mass and whose predictions depend only on the same inner structure. Two such examples, the very ones that lead originally to the understanding of the smallness of neutrino mass through the so-called seesaw mechanism, are provided by left-right symmetric theories and the $SO(10)$ grand unified theory. They provide the core of my lectures, and I dedicate one of the Appendices (D) to the group theory of $SO(2N)$ to in order to facilitate a reader's job. I also discuss in detail the $SU(5)$ grand unified theory, although in its minimal form it was tailor fit for massless neutrinos, just as the minimal standard model. However, a minimal extension needed to account for neutrino masses and mixings leads to exciting predictions of new particles and interactions likely to be tested at LHC. Furthermore, an understanding of $SO(10)$ becomes much easier after one masters a simple, minimal $SU(5)$ theory, which will always remain as a laboratory of the theory of grand unification and thus a large portion of these notes is devoted to it, including a short Appendix C. The readers familiar with $SU(5)$ can go directly to the subsection 5.5 relevant for neutrino mass.

I have included a number of exercises throughout the text which are important for the understanding of the material. I encourage the reader to go through them, including those in the Appendices.

Since my lectures are far from being complete, I suggest here to complement them with these two pedagogical exposes on the subject of neutrino masses and mixings. At the end of the lectures, I include some references for further reading.

1) Mohapatra, Pal [1]. An excellent book, with a detailed analysis of Majorana neutrinos, left-right symmetry, seesaw mechanism and $SO(10)$ grand unification, which provides the core of my lectures.

2) Strumia, Vissani review [2]. Highly recommended, especially for the phenomenology of neutrino masses and mixings. Very well written, continuously updated, concise, clear and surprisingly complete study of neutrino oscillations and related topics.

Regarding grand unification, I recommend the books by Mohapatra [3] and Ross [4].

Last but not least. I have tried to do justice in citations, to the field and to my peers, but it is impossible not to fail due to the lack of time and ignorance. I apologize in advance for any omission.

2 Introduction

The Standard Model (SM) of electro-weak and strong interactions is a remarkably successful theory of all particle forces but gravity. In its minimal version neutrinos are massless, but the observed tiny neutrino masses are easily accounted for through a new, high-energy physics; all it requires is to, say, add right-handed neutrinos, the SM singlets. True, one should find the Higgs particle in order to complete the theory, but to most of us it is only a question of time, rather likely to happen at LHC. Since it works so well, most of the attempts in building theories beyond the SM have focused on purely theoretical and even philosophical questions. One issue that stands out in my opinion is the disparity of three different forces based on SU(3), SU(2) and U(1) gauge groups. Particularly worrisome is the U(1), since its charge is not quantized, and the miracle of charge quantization in nature is accounted for by arbitrary U(1) quantum numbers. Things would be different if we had a single (or a product) non-abelian group, such as was the hope in the original proposal by Schwinger [5] of SU(2) as a unified theory of weak and electromagnetic interactions, long before the neutral currents were discovered. This guarantees charge quantization and is a prototype of any unified theory based on a simple gauge group. The neutral gauge boson of SU(2) was to be identified with the photon and one had

$$Q = T_3 \tag{1}$$

Thus the charges were automatically, but unfortunately wrongly, quantized (a heroic attempt to save the theory was made by Georgi and Glashow [6], before the discovery of neutral currents). This could have been considered as an example of a beautiful theory killed by the ugly facts of nature. For charge quantization in this theory is a profound and deep fact: if one breaks SU(2) down to $U(1)_{em}$ as spontaneously as renormalizability requires, one predicts the existence of magnetic monopoles [7, 8]. This means that all the charges must be quantized, not just the ones of the observed particles. One is assured that the fact will persist whatever new particles be discovered.

Four years after Schwinger, Glashow made a simple but important suggestion: he added the U(1) piece [9]. The rest as we know is history. Well, what was missing was to break the symmetry through the Higgs mechanism which was to follow six years later [10, 11], and everything fell in its place.

It seemed quite a blow though that one was forced to introduce the U(1) culprit to get the lepton and quark charges right. Now, in the SM model the charges are quantized due to anomaly cancellation, but that does not say anything about the particles not yet discovered, their charges do not have to be quantized. For example, the vector-like states may have arbitrary real number charges since their anomalies cancel automatically.

But then came SU(3) as a theory of strong interactions, and a wish to unify both weak and strong forces in a simple theory, based on a single gauge group. This then, besides unification, leads to charge quantization automatically, and furthermore the minimal theory based on SU(5) gauge group [12], also includes U(1) for free. There are two generic beautiful predictions of grand unification: proton decay and magnetic monopoles, the former due to the unification of quarks and leptons and the latter due to in-built quantization of electric charge. Whereas Dirac predicted charge quantization if magnetic monopoles exist [13], grand unification predicts the existence of monopoles. Both proton decay and magnetic monopoles were searched for desperately, alas, with no success. Furthermore, the minimal grand unified theory of both matter and interactions based on SO(10) gauge group predicts massive neutrinos, and connects neutrino masses and mixings with the ones of the quarks.

Today we know for fact that at least two neutrinos are massive and by analogy with quarks we need the leptonic mixing matrix. For the phenomenology of neutrino masses and mixings, see e.g. [2] and the the lectures by Strumia in this school.

We start by reviewing what the Standard Model (SM) says about neutrino masses and mixings.

2.1 Standard Model review

The minimal Standard Model (MSM) is an $SU(3) \times SU(2) \times U(1)$ gauge theory with the following fermionic assignment [9]

$$\begin{aligned}
 q_L &\equiv \begin{pmatrix} u \\ d \end{pmatrix}; & (u^c)_L, (d^c)_L \\
 \ell_L &\equiv \begin{pmatrix} \nu \\ e \end{pmatrix}; & (e^c)_L
 \end{aligned} \tag{2}$$

where we have omitted the color index for quarks and we work here with left-handed anti fermions instead of right-handed fermions (see Appendix A, formula (A11))

$$(\psi^C)_L \equiv C\bar{\psi}_R^T \quad (3)$$

Actually, we will sometimes work with right-handed fermions too (as in the section 4 on L-R symmetry), and it is important to be familiar and at ease with both notations.

The maximal parity violation in the usual charged weak interactions is characterized by the maximal asymmetry between left and right: only left-handed fermions interact with W^\pm gauge bosons. On top of that, the quark-lepton symmetry is broken by the minimality assumption: NO right-handed neutrinos. Hence a clear prediction: *neutrinos are massless*. In order to see that, recall that fermionic masses in the MSM stem from the Yukawa interactions with a Higgs doublet Φ

$$L_Y = y_u q_l^T C i \sigma_2 \Phi u_L^c + y_d q_l^T C \Phi^* d_L^c + y_l l_L^T C \Phi^* e_L^c + \text{h.c.} \quad (4)$$

where the generation index is suppressed for simplicity. An equivalent expression involves right-handed particles instead of left-handed anti-particles

$$L_Y = y_u \bar{q}_l i \sigma_2 \Phi^* u_R + y_d \bar{q}_l \Phi d_R + y_l \bar{l}_l \Phi e_R + \text{h.c.} \quad (5)$$

From the charge formula

$$Q = T_3 + Y/2 \quad (6)$$

The usual charges are reproduced with

$$Y_q = \frac{1}{3}, Y_\ell = -1, Y_{u_R} = \frac{4}{3}, Y_{d_R} = -\frac{2}{3}, Y_{e_R} = -2, Y_\Phi = 1 \quad (7)$$

Notice the physical interpretation for the hypercharge of the left-handed particles

$$Y_L = B - L \quad (8)$$

whereas Y_R has no physical interpretation and needs to be memorized.

The $B - L$ symmetry of the MSM is selected out: it is an anomaly free combination of accidental global symmetries B and L . In other words, $B - L$ can be gauged. We will come back often to this important and suggestive fact. The minimality of (2), the broken symmetry between quarks and leptons is thus responsible for the only failure of this, otherwise extremely successful, theory.

As it is, the MSM must be augmented in order to account for neutrino mass. If you insist, though, on the MSM degrees of freedom in (2), the Yukawa interactions that could lead to neutrino mass must clearly be higher dimensional [14]

$$\mathcal{L}_Y(d=5) = y_\nu \frac{(\ell_L^T C i \sigma_2 \Phi)(\phi^T i \sigma_2 \ell_L)}{M} \quad (9)$$

where the new scale M signifies some new physics.

Exercise: Show that there are only three possible $d=5$, $SU(2) \times U(1)$ invariant operators of type (9). Show then that they are all equivalent.

When the Higgs doublet gets a nonvanishing vacuum expectation value (vev)

$$\langle \Phi \rangle = \begin{pmatrix} 0 \\ v \end{pmatrix} \quad (10)$$

the charged fermions get the usual Dirac mass

$$m_f \bar{f} f \equiv m_f (\bar{f}_L f_R + \bar{f}_R f_L) \quad (11)$$

with $m_f = y_f v$. In the same manner, from (9) neutrino gets a Majorana mass [15]

$$m_\nu \nu_L^T C \nu_L \quad (12)$$

with

$$m_\nu = y_\nu \frac{v^2}{M} \quad (13)$$

If $M \gg v$, neutrinos are automatically lighter than the charged fermions; however if $M \simeq v$ (or even $M \ll v$), small m_ν may result from $y_\nu \ll 1$. Since this is an effective theory, we can say nothing about m_ν . In short, the absence of new light degrees of freedom, indicates Majorana neutrino masses and the violation of the lepton number at the new scale M .

From (9) and (12), one has $\Delta L = 2$ which allows for the neutrinoless double beta decay $\beta\beta 0\nu$ [16] [17].

$$n + n \rightarrow p + p + e + \bar{e} \quad (14)$$

It is often argued that $\beta\beta 0\nu$ probes m_M , however, the situation is more complex. Namely, the MSM with neutrino Majorana mass is not a complete theory –it must be completed through a $d=5$ operator (9) and a new physics at M . We will see that the predictions for $\beta\beta 0\nu$ depend on the completion, to which we now turn to.

The effective operator (9) is useful in discussing the qualitative nature of neutrino mass, but if we wish to probe the origin of neutrino masses we need

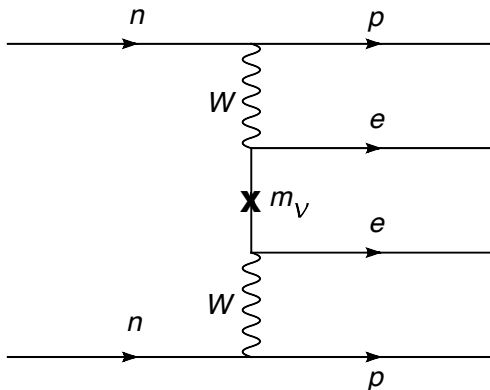

Figure 1: Neutrinoless double β decay through a Majorana mass m_M which breaks a neutrino fermionic line

a renormalizable theory beyond the MSM. There are infinitely many different possibilities of completing the MSM which all lead to the d=5 operator upon integrating out the new physics, so we cannot a priori say anything about the physics behind it. The situation simplifies if one assumes adding only one type of new particles in which case there are only three different ways of completing MSM. These are three different seesaw mechanisms.

3 The see-saw mechanism

We discuss here different realizations of the see-saw mechanism, in order of their popularity which also coincides with the historic development. The idea is a renormalizable completion of the MSM that will lead to small neutrino mass. The end result must be a d=5 operator discussed above, since that is dictated by the MSM gauge symmetry, as long as new physics is at a scale above M_W .

3.1 Right-handed neutrinos: Type I see-saw

The most suggestive completion of the MSM is the introduction of ν_R (per family of fermions), a gauge singlet chiral fermion. This is a right handed neutrino, whose existence is appealing from the structural quark - lepton symmetry. A new renormalizable Yukawa coupling (written here for one generation case only) then follows

$$\Delta\mathcal{L} = y_D \bar{\ell}_L \sigma_2 \Phi^* \nu_R + \frac{M_R}{2} \nu_R^T C \nu_R + h.c. \quad (15)$$

Introduce

$$\begin{aligned}\nu &\equiv \nu_L + C\bar{\nu}_L^T \\ N &\equiv \nu_R + C\bar{\nu}_R^T\end{aligned}\tag{16}$$

which gives the mass matrix for ν and N (see Appendix B)

$$\begin{pmatrix} 0 & m_D \\ m_D^T & M_R \end{pmatrix}\tag{17}$$

If $M_R \ll m_D$, neutrinos would be predominantly Dirac particles. For $M_R \simeq m_D$, we have a messy combination of Majorana and Dirac, whereas for $m_D \ll M_R$ we would have a predominantly Majorana case [this case is rather interesting, since the gauge invariant scale M_R is expected to be above M_W : $M_R > M_W$]. In this case the approximate eigenstates are N with mass $M_N \equiv M_R$ and ν with a tiny mass

$$M_\nu = -m_D^T \frac{1}{M_N} m_D\tag{18}$$

This is the original see-saw formula [18][19] [20] [21], today called Type I. As we know from (9), with heavy ν_R , neutrino mass must be of the type (12), confirmed here.

Exercise: *Prove explicitly (17) in the case of two generations. Hint: work with m_D diagonal.*

It is clear from (17) that the number of ν_R 's determines the number of massive light neutrinos: for each ν_R , only one ν_L gets a mass. In other words, we need at least two ν_R 's in order to account for both solar and atmospheric neutrino mass differences. It is suggestive, though, to have a ν_R per family, in which case an accidental anomaly free global symmetry of the MSM can be gauged. A neutrino per generation is needed to cancel $U(1)_{B-L}^3$ anomaly.

The diagrammatic representation of the see-saw in Fig.2 may be even more clear; it is easy to see that the heavy neutrino propagator gives the see-saw result.

3.2 $Y = 2$, $SU(2)_L$ triplet Higgs: Type II see-saw

Instead of ν_R , a $Y = 2$ triplet $\Delta_L \equiv \vec{\Delta}_L \cdot \vec{\sigma}$ can play the same role [22] [23] [24]. From the new Yukawas

$$\Delta\mathcal{L}(\Delta) = y_\Delta^{ij} \ell_i^T C \Delta_L \ell_j + h.c.\tag{19}$$

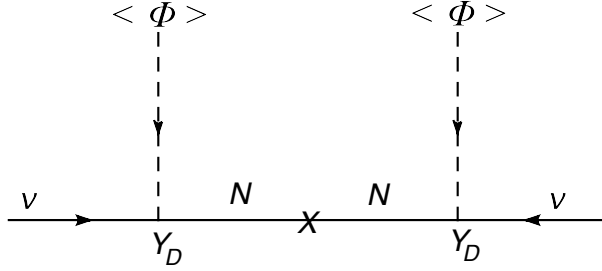

Figure 2: Diagrammatic representation of the Type I see-saw

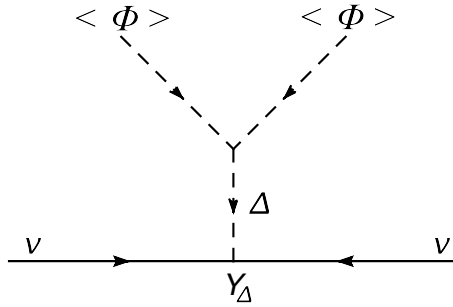

Figure 3: Diagrammatic representation of the Type II see-saw

where $i, j = 1, \dots, N$ counts the generations, neutrinos get a mass when Δ_L gets a vev

$$M_\nu = y_\Delta \langle \Delta \rangle \quad (20)$$

The vev $\langle \Delta \rangle$ results from the cubic scalar interaction

$$\Delta V = \mu \Phi^T \sigma_2 \Delta_L^* \Phi + M_\Delta^2 \text{Tr} \Delta_L^\dagger \Delta_L + \dots \quad (21)$$

with

$$\langle \Delta \rangle \simeq \frac{\mu v^2}{M_\Delta^2} \quad (22)$$

where one expects μ of order M_Δ . If $M_\Delta \gg v$, neutrinos are naturally light. Notice that (20) and (22) reproduce again the formula (12) as it must be: for large scales of new physics, neutrino mass must come from $d = 5$ operator in (9).

Again, the diagrammatic representation may be even more clear, see Fig. 3.

3.3 $Y = 0$, $SU(2)_L$ triplet fermion: Type III see-saw

The Yukawa interaction in (15) for new singlet fermions carries on straightforwardly to $SU(2)$ triplets too, written now in the Majorana notation (where

for simplicity the generation index is suppressed and also an index counting the number of triplet - recall that at least two are needed in order to provide two massive light neutrinos)

$$\Delta\mathcal{L}(T_F) = y_T \ell^T C \sigma_2 \vec{\sigma} \cdot \vec{T}_F \Phi + M_T \vec{T}_F^T C \vec{T}_F \quad (23)$$

In exactly the same manner as before in Type I, one gets a Type III see-saw [25] for $M_T \gg v$

$$M_\nu = -y_T^T \frac{1}{M_T} y_T v^2 \quad (24)$$

Again, as in the Type I case, one would need at least two such triplets to account for the solar and atmospheric neutrino oscillations (or a triplet and a singlet). And, as before, (24) simply reproduces (12) for large M_T , and $SU(2) \times U(1)$ symmetry dictates.

Under the assumption of single type of new particles added to the SM, these three types of see-saw exhaust all the possibilities [26] of reproducing (9) and (12).

Exercise: *Show that the three possible different operators of the type (9) correspond to the three different types of see-saw.*

Since (9) and (12) describe effectively neutrino Majorana masses in the MSM, the question is whether we gain anything by going to be the renormalizable see-saw scenarios. If the new scales M_R, M_Δ and M_T are huge and not accessible to experiment, then arguably (17), or (20) and (22), or (24), are equivalent to the (9) or (12). In a sense, they are only a change of language, but not a useful language. We have traded the couplings y_ν between physical, observable particles, to the unknown y_D (or y_Δ or y_T) couplings and the unknown masses of the heavy particles that we integrate out.

The issue, in any case, is not so much to explain the smallness of neutrino mass, but to relate it to some other physical phenomenon. After all, small fermion masses are controlled by small Yukawa couplings.

This is reminiscent of the Fermi theory of weak interactions. At low energies $E \ll M_W$, the concept of a massive gauge boson W was not useful and for many years one kept working on the Fermi theory instead. For otherwise, one would be trading the interactions between light physical states for the unknown coupling with W and unknown M_W .

There are two cases when one is better off talking of W , though

1. when one can reach the energy $E \simeq M_W$ and thus make W experimentally accessible

2. even when $E \ll M_W$, but one has a dynamical theory of W interactions as in the MSM. The $SU(2) \times U(1)$ gauge symmetry of MSM made clear predictions at low energies by correlating charged and neutral current processes.

Ideally, we would like both 1 and 2. By complete analogy, we need then either M_R , M_Δ or M_T close to M_W in order to be accessible at LHC, or we need a theory of new interactions. The nice example for the latter is Grand Unification: through $q - \ell$ symmetry it in principle correlates quark and lepton masses and mixings.

A particularly appealing GUT is $SO(10)$, since it unifies a family of fermions and has $L - R$ symmetry as a finite gauge transformation in the form of Dirac's charge conjugation. I will be discussing it at length later; for the moment suffice it to say that it predicts both Type I and Type II see-saw, but in minimal predictive versions their scale is very large, much above M_W – and hopeless to detect directly. The type III seesaw, though, is predicted naturally in a minimal realistic extension of the original $SU(5)$ grand unified theory. This will be covered too towards the end of the course.

In summary, the main message of this chapter should be that the Majorana neutrino mass is rather suggestive from the theoretical point of view. As such, it provides a window to new physics at scale M of (9). The crucial prediction of this picture is the $\Delta L = 2$ lepton number violation in processes such as $\beta\beta 0\nu$. However, $\beta\beta 0\nu$ depends in general on the new physics at scale M , and it is desirable to have a direct probe of lepton number violation. In 1983, Keung and I [27] suggested $\Delta L = 2$ production of same sign dileptons at colliders, accompanied by jets, as a direct probe of the origin of neutrino mass. We will discuss lepton number violation at length in Section 7.

What happens if the neutrino has a pure Dirac mass? In this case, $m_\nu = y_D v$ and the smallness of m_ν simply requires the smallness of y_D . The smallness of m_ν remains a puzzle controlled by small y_D , as much as the smallness of m_e is controlled by a small electron Yukawa coupling. The MSM with Dirac couplings is a complete theory and needs no theory beyond it. The diversity of fermion masses and mixings encourages though many workers in the field to look for flavor symmetries at high energies. The danger here is to be caught in semantics rather in physics, for one often trades the known masses and mixings of the physical states for the unmeasurable properties of the new heavy particles and/or textures of mass matrices that cannot be probed. This is a generic problem of large scale theories and in order to verify them we would need to correlate the neutrino masses and mixings with some new physics. A nice example is proton decay in GUTs, to which we will come later.

4 Left-right symmetry and neutrino mass

This Section is devoted to the left-right symmetric extension of the standard model and the issue of the origin of the breaking of parity. This theory played an important historic role in leading automatically to nonzero neutrino masses and the seesaw mechanism. There are two different possible left-right symmetries: parity and charge conjugation. The latter is the finite gauge transformation in $SO(10)$, and is thus rather suggestive. Still, parity is normally identified with L-R symmetry, so I discuss next parity. The write-up here is rather simple and pedagogical, without too many technicalities.

4.1 Parity as L-R symmetry

Parity is the fundamental symmetry between left and right and its breaking, I believe, should be understood. In the standard model P is broken explicitly and clearly, in order to break P spontaneously we must enlarge the gauge group. The minimal model is based on the gauge group [28, 29, 30, 31].

$$G_{LR} = SU(2)_L \times SU(2)_R \times U(1)_{Y'}$$

with the quarks and leptons completely symmetric under $L \leftrightarrow R$

$$\begin{aligned} Q_L = \begin{pmatrix} u \\ d \end{pmatrix}_L & \xleftrightarrow{P} Q_R = \begin{pmatrix} u \\ d \end{pmatrix}_R \\ \ell_L = \begin{pmatrix} \nu \\ e \end{pmatrix}_L & \xleftrightarrow{P} \ell_R = \begin{pmatrix} \nu \\ e \end{pmatrix}_R \end{aligned} \quad (25)$$

Notice that the requirement of left-right symmetry leads to the existence of the right-handed neutrino and now the neutrino mass becomes a dynamical issue, related to the pattern of symmetry breaking. In the Standard Model, where ν_R is absent, $m_\nu = 0$; here instead we shall need to explain why neutrinos are so much lighter than the corresponding charged leptons.

In this theory, the formula for the electromagnetic charge becomes

$$Q_{em} = I_{3L} + I_{3R} + \frac{B - L}{2} \quad (26)$$

This is in sharp contrast with the Standard Model, where the hypercharge Y was completely devoid of any physical meaning. So L-R symmetry is deeply connected with B-L symmetry; the existence of right-handed neutrinos implied by L-R symmetry is necessary in order to cancel anomalies when gauging B-L. Namely, the B-L symmetry is a global anomaly free symmetry of the SM, but without ν_R the gauged version would have $(B - L)^3$ anomaly.

Our primary task is to break L-R symmetry, i.e. to account for the fact that $M_{W_R} \gg M_{W_L}$, W_R and W_L denoting right-handed and left-handed gauge bosons respectively. In order to do so we need a set of left-handed and right-handed Higgs scalars whose quantum numbers we will specify later. Imagine for the moment two scalars φ_L and φ_R with

$$\varphi_L \xleftrightarrow{P} \varphi_R \quad (27)$$

Assume no terms linear in the fields (since φ_L and φ_R should carry quantum numbers under $SU(2)_L$ and $SU(2)_R$) we can write down the left-right symmetric potential

$$V = -\frac{\mu^2}{2}(\varphi_L^2 + \varphi_R^2) + \frac{\lambda}{4}(\varphi_L^4 + \varphi_R^4) + \frac{\lambda'}{2}\varphi_L^2\varphi_R^2 \quad (28)$$

where $\lambda > 0$ in order for V to be bounded from below, and we choose $\mu^2 > 0$ in order to achieve symmetry breaking in the usual manner. We rewrite the potential as

$$V = -\frac{\mu^2}{2}(\varphi_L^2 + \varphi_R^2) + \frac{\lambda}{4}(\varphi_L^2 + \varphi_R^2)^2 + \frac{\lambda' - \lambda}{2}\varphi_L^2\varphi_R^2 \quad (29)$$

which tells us that the pattern of symmetry breaking depends crucially on the sign of $\lambda' - \lambda$, since the first two terms do not depend on the direction of symmetry breaking (of course $\mu^2 > 0$ guarantees that $\langle \varphi_L \rangle = \langle \varphi_R \rangle = 0$ is a maximum and not a minimum of the potential).

Exercise: *Show that if*

1. $\lambda' - \lambda > 0$, in order to minimize V we have either $\langle \varphi_L \rangle = 0$, $\langle \varphi_R \rangle \neq 0$, or vice versa. Due to the symmetry of V both solutions are equally probable.
2. $\lambda' - \lambda < 0$, we need $\langle \varphi_L \rangle \neq 0 \neq \langle \varphi_R \rangle$ and L-R symmetry implies $\langle \varphi_L \rangle = \langle \varphi_R \rangle$.

Obviously we choose 1., which implies that P is broken in nature [30, 31].

4.2 Left-Right symmetry and massive neutrinos

What fields should we choose for the role of φ_L and φ_R ? From the neutrino mass point of view, the ideal candidates should be triplets [18] [21], i.e.

$$\Delta_L(\bar{3}_L, 1_R, 2) \quad ; \quad \Delta_R(\bar{1}_L, 3_R, 2) \quad (30)$$

where the quantum numbers denote $SU(2)_L$, $SU(2)_R$ and $B - L$ transformation properties. Simply speaking, Δ_L and Δ_R are $SU(2)_L$ and $SU(2)_R$ triplets, respectively, with $B - L$ numbers equal to two.

Writing $\Delta_{L,R} = \Delta_{L,R}^i \tau_i / 2$ (τ_i being the Pauli matrices) as is usual for the adjoint representations, we find Yukawa couplings

$$\mathcal{L}_\Delta = h_\Delta (\ell_L^T C i\tau_2 \Delta_L \ell_L + L \rightarrow R) + h.c. \quad (31)$$

To check the invariance of (31) under the Lorentz group and the gauge symmetry $SU(2)_L \times SU(2)_R \times U(1)_{B-L}$, recall

- that $\psi_L^T C \psi_L$ is a Lorentz invariant quantity for a chiral Weyl spinor ψ_L (and similarly for ψ_R).
- under the gauge symmetry $SU(2)_L$

$$\begin{aligned} \ell_L &\longrightarrow \mathcal{U}_L \ell_L \quad , \quad \Delta_L \longrightarrow \mathcal{U}_L \Delta_L \mathcal{U}_L^\dagger \\ \mathcal{U}_L^T (i\tau_2) &= (i\tau_2) \mathcal{U}_L^\dagger \end{aligned} \quad (32)$$

and similarly for $SU(2)_R$

- the B-L number of the $\Delta_{L,R}$ fields is two.

This proves the invariance of (31) under all the relevant symmetries. Now, from their definition, the fields $\Delta_{L,R}$ have the following decomposition under the charge eigenstates

$$\Delta_{L,R} = \left[\begin{array}{cc} \Delta^+ / \sqrt{2} & \Delta^{++} \\ \Delta^0 & -\Delta^+ / \sqrt{2} \end{array} \right]_{L,R} \quad (33)$$

where we use the fact that $Tr \Delta_{L,R} = 0$ and the charge is computed from $Q = I_{3L} + I_{3R} + (B - L)/2$.

Notice an interesting consequence of doubly charged physical Higgs scalars in this theory. From the general analysis of the spontaneous L-R symmetry breaking, we know that for a range of parameters of the potential the minimum of the theory can be chosen as

$$\langle \Delta_L \rangle = 0 \quad , \quad \langle \Delta_R \rangle = \left[\begin{array}{cc} 0 & 0 \\ v_R & 0 \end{array} \right] \quad (34)$$

From (31), we then obtain the mass for the right-handed neutrino ν_R

$$\mathcal{L}_m = h_\Delta v_R (\nu_R^T C \nu_R + \nu_R^\dagger C^\dagger \nu_R^*) \quad (35)$$

Thus the right-handed neutrino gets a large mass $M_R = h_\Delta v_R$, which corresponds to the scale of breaking of parity. At the same time, the original gauge symmetry is broken down to the Standard Model one

$$SU(2)_L \times SU(2)_R \times U(1)_{B-L} \xrightarrow{\langle \Delta_R \rangle} SU(2)_L \times U(1)_Y \quad (36)$$

This can be checked by computing the gauge boson mass matrix. By defining the right-handed charged gauge boson

$$W_R^\pm = \frac{A_R^1 \mp iA_R^2}{\sqrt{2}} \quad (37)$$

we get

$$M_{W_R}^2 = g_R^2 v_R^2 \quad (38)$$

$$M_{Z_R}^2 = 2(g^2 + g_{B-L}^2) v_R^2 \quad (39)$$

where

$$Z_R = \frac{g_{B-L} A_R^3 + g_R A_{B-L}}{\sqrt{g^2 + g_{B-L}^2}} \quad (40)$$

is the new massive neutral gauge field, and g_R and g_{B-L} gauge couplings correspond to $SU(2)_R$ and $(B-L)/2$, respectively.

Thus the scale of parity breaking is related to the mass of the right-handed charged gauge bosons W_R^\pm . The predominant V-A nature of the weak interactions puts a lower limit on M_{W_R} , but the limit depends on the details of the model. In general the left and right mixings between quarks (and leptons too) are not correlated and M_{W_R} can be quite low. If the L and R mixings are the same (or approximately the same) as in some minimal versions of the theory, the best limit comes from $K_L - K_S$ mass difference

$$M_{W_R} \gtrsim 2\text{TeV} \quad (41)$$

There have been recent claims of $M_{W_R} \gtrsim 4\text{TeV}$ [73] (or even $M_{W_R} \gtrsim 10\text{TeV}$ [74]) in the minimal theory, but these limits depend on the definition of $L-R$ asymmetry and its manifestness. $L-R$ symmetry can be P as in the original works or C as it happens in SO(10) (see the next subsection). The authors of [73, 74] use P, but one must check for C too. Furthermore, they argue in favor of almost manifest L-R symmetry, which is open to questioning.

To complete the theory, one needs a Higgs bidoublet which contains the SM Higgs, so that one can give masses to quarks and leptons. In the process we get the Dirac neutrino mass between ν_L and ν_R and in turn we end up with the type I see-saw mechanism for light neutrino masses.

Type I see-saw From the Dirac Yukawas

$$\mathcal{L} = h_\Phi \bar{\ell}_L \Phi \ell_R + h.c. \quad (42)$$

after the symmetry breaking the neutrino Dirac mass term is $m_D = h_\Phi \langle \Phi \rangle$. The neutrino mass terms become

$$m_D \bar{\ell}_L \ell_R + M_R \ell_R^T C \ell_R + h.c. \quad (43)$$

and the neutrino mass matrix takes clearly the seesaw form.

The important point here is that the mass of ν_R is determined by the scale of parity breaking and the smallness of the neutrino mass is a reflection of the predominant V-A structure of the weak interaction and provides a probe of parity restoration at high energies $E > M_{W_R}$.

Type II see-saw The gauge symmetry of the Left-Right model allows also for the following term in the potential that we have ignored before for simplicity

$$\Delta V = \alpha \Delta_L^\dagger \Phi \Delta_R \Phi^\dagger \quad (44)$$

which implies that $\langle \Delta_L \rangle$ cannot vanish [24].

Exercise: *Show that*

$$\langle \Delta_L \rangle \simeq \alpha \frac{M_W^2 \langle \Delta_R \rangle}{M_{\Delta_L}} \simeq \alpha \frac{M_W^2}{M_R} \quad (45)$$

which leads to type II see-saw.

The predictions for neutrino mass depend crucially on M_{W_R} , but the L-R symmetric model by itself cannot give us its value. This is cured in SO(10) grand unified theory, where we will see that this scale tends to be very large, far above the TeV energy scale of LHC. This is unfortunate.

4.3 Charge conjugation as L-R symmetry

Since charge conjugation (see Appendix A)

$$(\psi^C)_L \equiv C \bar{\psi}_R^T \quad (46)$$

is also a transformation between left and right, one can as well use C as a L-R symmetry of this theory. In the limit of CP invariance, these symmetries are equivalent; the difference lies only in the tiny breaking of CP. The above

discussion goes almost unchanged and we leave it as an exercise for a reader to go through.

Exercise: Rewrite the above left-right symmetric theory, both gauge and Yukawa couplings with L - R symmetry as C instead of P .

We will see that in $SO(10)$ this symmetry introduced here ad-hoc, is an automatic finite gauge transformation. It would be natural to go directly to $SO(10)$ now, but it will be helpful to master first the minimal grand unified theory based on $SU(5)$ symmetry. In order to be as pedagogical as possible, I have included Appendices C and D on $SU(N)$ and $SO(2N)$ groups, respectively. In particular, Appendix D deals with the spinorial representations of $SO(2N)$, a possibly new topic for most of the readers. There are a number of exercises that should help you know whether you have a mastery of the necessary group theory.

5 SU(5): A Prototype GUT

The minimal group that can unify the Standard Model (SM) is $SU(5)$ [12], a group of rank four. It is actually the minimal group that can unify the $SU(2)_L$ and $SU(3)_c$ of the SM, the $U(1)$ comes for free.

It is natural that we should try to put the electro-weak doublet Φ and the new color triplet h_α in the 5-dimensional fundamental representation

$$5_H = \Phi = \left(\begin{array}{c} h^r \\ h^g \\ h^b \\ \phi^+ \\ \phi^0 \end{array} \right) \left. \begin{array}{l} \} SU(3)_c \\ \} SU(2)_L \end{array} \right\} \quad (47)$$

where in the obvious notation the $SU(3)_c$ symmetry is acting on the first 3 components and the $SU(2)_L$ on the last two.

5.1 Structure

5.1.1 Fermions

We have 15 Weyl fields in each generation and it is natural to try to put them in a 15-dimensional symmetric representation of $SU(5)$. Now

$$5 \otimes 5 = 15_s + 10_{as} \quad (48)$$

Since $5 = (3_c, 1_L) + (1_c, 2_L)$ (in an obvious notation), since $(3_c \otimes 3_c)_s = 6_c$, and since quarks come only in color triplets, we must abandon the idea of 15_S . It is not anomaly free anyway, it could not have worked. What about 5 and 10_{as} ? The quantum numbers of 5 from (47) imply uniquely

$$5_F \equiv \psi = \begin{pmatrix} d^r \\ d^g \\ d^b \\ e^+ \\ -\nu^C \end{pmatrix}_R \quad (49)$$

(recall that $(f^C)_R \equiv C \bar{f}_L$).

Now, from $\psi \rightarrow U\psi$ under $SU(5)$, the 10-dimensional representation $10_F \equiv \chi$ must transform as

$$\chi \rightarrow U \chi U^T \quad (50)$$

This is enough to give the quantum numbers of the particles in 10_F

$$\chi = \frac{1}{\sqrt{2}} \begin{bmatrix} 0 & u_b^C & -u_r^C & -u^r & -d^r \\ -u_b^C & 0 & u_r^C & -u^g & -d^g \\ u_g^C & -u_r^C & 0 & -u^b & -d^b \\ u^r & u^g & u^b & 0 & e^+ \\ d^r & d^g & d^b & -e^+ & 0 \end{bmatrix}_L \quad (51)$$

Notice that in (49), a minus sign convention for the ν^C field is to ensure that $\begin{pmatrix} e^+ \\ -\nu^C \end{pmatrix}_R$ and $\begin{pmatrix} e \\ \nu \end{pmatrix}_L$ transform identically, and in (51) the signs are the property of χ being antisymmetric. We will work in the future with 10_F and $\bar{5}_F$ (instead of 5_F).

We can see furthermore that a unified theory such as $SU(5)$ explains charge quantization, i.e. it relates quark and lepton charges. From (49)

$$Q(d^C) = -\frac{1}{3}Q(e) = \frac{1}{3} \quad (52)$$

and then from (51) we see that $Q(u) = Q(d) + 1 = 2/3$.

5.1.2 Interactions

The interactions of fermions with gauge bosons are

$$\mathcal{L}_f = i\bar{\psi}\gamma^\mu D_\mu\psi - iT r \bar{\chi}\gamma^\mu D_\mu\chi \quad (53)$$

where

$$D_\mu \chi = \partial_\mu \chi - ig(\mathcal{A}_\mu \chi + \chi \mathcal{A}_\mu^T) \quad (54)$$

There are of course the old QCD and $SU(2)_L \times U(1)$ interactions with $g_s = g_W = g$, and $\sin^2 \theta_W = 3/8$, the couplings at the unification scale where full $SU(5)$ is operative. Furthermore, there are new X and Y bosons who carry both color and flavor with charges $4/3$ and $1/3$ respectively. Their interactions are

$$\begin{aligned} \mathcal{L}(X, Y) = & \frac{g}{\sqrt{2}} \bar{X}_\mu^\alpha [\bar{d}_{\alpha R} \gamma^\mu e_R^+ + \bar{d}_{\alpha L} \gamma^\mu e_L^+ + \epsilon_{\alpha\beta\gamma} \bar{u}_L^{c\gamma} \gamma_\mu u_{\beta L}] \\ & + \frac{g}{\sqrt{2}} \bar{Y}_\mu^\alpha [-\bar{d}_{\alpha R} \gamma^\mu \nu_R^C + \bar{u}_{\alpha L} \gamma^\mu e_L^+ + \epsilon_{\alpha\beta\gamma} \bar{u}_L^{c\gamma} \gamma_\mu d_{\beta L}] + h.c. \end{aligned} \quad (55)$$

As expected, due to the nontrivial color and flavor characteristics of the quarks, the X and Y couple to the quark-quark and quark-lepton states. It is clear that B and L are violated, although for some magic reason $B - L$ is conserved (more about it later). This leads to the decay of the proton, as can be seen from the effective upon integrating out the heavy X and Y gauge bosons

$$\mathcal{L}_{\text{eff}}(X, Y) \simeq \frac{g^2}{M_X^2} QQQ L \quad (56)$$

where Q and L can stand generically for quarks and leptons.

By analogy with the usual muon decay, the proton decay rate can be estimated as

$$\Gamma_p \simeq \frac{g^4}{M_X^4} m_p^5 \quad (57)$$

From $(\tau_p)_{\text{exp}} \gtrsim 10^{33} \text{yr}$ we get $M_X \gtrsim 10^{15.5} \text{GeV}$; later we will show that we can actually compute M_X .

5.2 Symmetry Breaking

The first stage of symmetry breaking down to the SM is achieved by the adjoint Higgs $\Sigma = 24_H$. Assume, only for the sake of simplicity, the discrete symmetry $\Sigma \rightarrow -\Sigma$. Then the most general renormalizable potential for Σ is given by

$$V(\Sigma) = -\frac{\mu^2}{2} \text{Tr} \Sigma^2 + \frac{1}{4} a (\text{Tr} \Sigma^2)^2 + \frac{1}{2} b \text{Tr} \Sigma^4 \quad (58)$$

Now, since $\langle \Sigma \rangle$ is a Hermitean matrix it can be diagonalized by an $SU(5)$ rotation. Assume now that it is in the same direction as the hypercharge: $\langle \Sigma \rangle \propto Y = v_X \text{diag}(1, 1, 1, -3/2, -3/2)$.

From (58) you get then $\mu^2 = \frac{1}{2}(15a + 7b) v_X^2$, which, for $\mu^2 > 0$, implies $(15a + 7b) > 0$.

In order to check that this is a local minimum, we must show that all the second derivatives are positive. Since Σ has exactly the same form as the gauge boson matrix, we can write

$$\Sigma = \langle \Sigma \rangle + \begin{pmatrix} \Sigma_8 + \sqrt{\frac{3}{5}} \left(-\frac{2}{3}\right) 1_c \Sigma_0 & \bar{\Sigma}_X & \bar{\Sigma}_Y \\ \Sigma_X & \sqrt{\frac{1}{2}} \Sigma_3 + \sqrt{\frac{3}{5}} \Sigma_0 & \Sigma^+ \\ \Sigma_Y & \Sigma^- & -\sqrt{\frac{1}{2}} \Sigma_3 + \sqrt{\frac{3}{5}} \Sigma_0 \end{pmatrix} \quad (59)$$

where Σ_8 are the analogs of gluons, Σ_X and Σ_Y the analogs of X and Y , Σ_3 , Σ^+ , Σ^- and Σ_0 the analogs of W^3 , W^+ , W^- and B , respectively. The masses of the particle masses in Σ are

$$\begin{aligned} m^2(\Sigma_8) &= \frac{5}{4} b v_X^2 \\ m^2(\Sigma_3) &= m^2(\Sigma_{\pm}) = 5b v_X^2 \\ m^2(\Sigma_0) &= \frac{15a + 7b}{2} v_X^2 \\ m^2(\Sigma_X) &= m^2(\Sigma_Y) = 0 \end{aligned} \quad (60)$$

Thus for $15a + 7b > 0, b > 0$ the extremum is a local minimum of the theory. Notice that Σ_X and Σ_Y are would-be Goldstone bosons of the theory; they get “eaten” by the X and Y gauge fields, i.e. they become their longitudinal components.

Finally, one can show that the vev of Σ is actually a global minimum. In fact, other extrema can be shown to be at best saddle points.

Exercise:

HARD. Prove that the above minimum is in fact global. Hint: show that the only possible minima are the $SU(5)$, $SU(4) \times U(1)$ and $SU(3) \times SU(2) \times U(1)$. Then show that for the above conditions of the SM minimum, the other two extrema are the maxima.

Thus $SU(5)$ can be successfully broken down to the standard model, since as we said Y commutes with both the $SU(3)_c$ and $SU(2)_L \times U(1)_Y$ generators. This will be even more evident from the study of the gauge bosons mass matrix. Since Σ is in the adjoint representation, $D_\mu \Sigma = \partial_\mu \Sigma - ig[\mathcal{A}_\mu, \Sigma]$, and one has

$$\frac{1}{2}(D_\mu \langle \Sigma \rangle)^\dagger (D^\mu \langle \Sigma \rangle) = \frac{25}{8}g^2v_X^2 [\bar{X}_\mu^a X_a^\mu + \bar{Y}_\mu^a Y_a^\mu] \quad (61)$$

where a as usual is the color index, $a = r, g, b$. As expected, the gluons and the electro-weak gauge bosons remain massless, but X and Y get equal masses

$$m_X^2 = m_Y^2 \equiv M_X^2 = \frac{25}{8}g^2v_X^2 \quad (62)$$

as a consequence of both $SU(3)_c$ and $SU(2)_L$ remaining unbroken. The original $SU(5)$ symmetry is broken down to $SU(3)_c \times SU(2)_L \times U(1)_Y$.

The rest of the breaking is completed by a 5-dimensional Higgs multiplet Φ_5 which contains the Standard Model doublet. Let us study this in some detail including the full $SU(5)$ invariant potential. We can write

$$\begin{aligned} V(\Sigma, \Phi) &= -\frac{\mu_\Sigma^2}{2} Tr \Sigma^2 + \frac{1}{4}a(Tr \Sigma^2)^2 + \frac{1}{2}b Tr \Sigma^4 \\ &- \frac{\mu_\Phi^2}{2} \Phi^\dagger \Phi + \frac{\lambda}{4}(\Phi^\dagger \Phi)^2 \\ &+ \alpha \Phi^\dagger \Phi Tr \Sigma^2 - \beta \Phi^\dagger \Sigma^2 \Phi \end{aligned} \quad (63)$$

with $a > 0$, $\lambda > 0$, $15a + 7b > 0$ and $\beta > 0$. Since both $SU(3)_c$ and $SU(2)_L$ are unbroken at this point, we can always rotate $\langle \Phi \rangle$ into the form $\langle \Phi^T \rangle = (v_c, 0, 0, 0, v_W)$. It is only the β term that is sensitive to the direction of $\langle \Phi \rangle$ and it gives $-\beta v_X^2(v_c^2 + 9/4v_W^2)$, which for $\beta > 0$ forms the solution $v_W \neq 0$, $v_c = 0$ in order to minimize the energy.

It is an easy exercise to compute the mass of the colored triplet scalar h_a in $\langle \Phi \rangle$, it is $m_h^2 = \frac{5}{2}\beta v_X^2$, which justifies the choice $\beta > 0$. It is also easy to show that

$$M_W^2 = \frac{g^2}{4\lambda} \left[\mu_\Phi^2 + \frac{8M_X^2}{25g^2}(-15\alpha + \frac{9}{2}\beta) \right] \quad (64)$$

But $M_X \gtrsim 10^{15} GeV$, which implies an extraordinary fine-tuning in the above equation of at least 26 orders of magnitude since the number on the right hand side of (64) is naturally of order M_X^2 . This is known as *the hierarchy problem*.

In the next subsection we will see that the colored triplet h_a mediates proton decay and thus it must be very heavy: $m_h \gtrsim 10^{12} GeV$, implying that

β cannot be taken arbitrarily small. This aspect of the hierarchy problem is known as the *doublet-triplet splitting problem*.

Before we close this subsection, let us say a few words more on the hierarchy problem. The problem is that the mass term for the Higgs scalars cannot be made small (or zero) by any symmetry, unlike the case of fermions. There the limit $m_f = 0$ leads to chiral symmetry and thus the higher order corrections must also vanish if $m_f = 0$ at the tree level. In other words, the higher order corrections are necessarily proportional to $m_f(\text{tree})$, and so only logarithmically divergent. In the case of scalars the divergence is quadratic and thus in the context of grand unified theories (GUTs) such as $SU(5)$ the natural value for M_W is of order M_X .

5.3 Yukawa Couplings and Fermion mass relations not necessary

In the Standard Model the left-handed fermions are doublets and the right-handed fermions are singlets, and so their chiral property is more than manifest. In $SU(5)$ the V-A structure of a family of fermions is left-intact and here also there are no direct mass terms for fermions.

In the minimal $SU(5)$ theory the fermion masses originate through the Yukawa couplings of fermions with the light Higgs Φ

$$\mathcal{L}_Y = f_d \bar{\psi}_R \chi \Phi^\dagger + f_u \frac{1}{2} \chi^T C \chi \Phi + h.c. \quad (65)$$

where C is the Dirac conjugation matrix, and f_u is clearly a symmetric matrix. The symbolic notation of (65) should read in the $SU(5)$ notation as

$$\begin{aligned} \bar{\psi}_R \chi \Phi^\dagger &= \bar{\psi}_{Ri} \chi^{ij} \Phi_j^\dagger \\ \chi^T C \chi \Phi &= \epsilon_{ijklm} (\chi^T)^{ij} C \chi^{kl} \Phi^m \end{aligned} \quad (66)$$

With $\langle \Phi \rangle^T = (0 \ 0 \ 0 \ 0 \ v_W)$, we get for fermionic masses

$$\begin{aligned} \mathcal{L}_m &= f_d v_W (\bar{d}_R d_L + \bar{e}_R^+ e_L^+) - f_u v_W (u^c)_L^T C u_L + h.c. \\ &= -[f_d v_W (\bar{d}d + \bar{e}e) - f_u v_W \bar{u}u] \end{aligned} \quad (67)$$

Minimal $SU(5)$ predicts the same masses for charged leptons and down quarks: $m_d = m_\ell$ [48].

Exercise:

Explain why $m_d = m_\ell$.

Unfortunately, this works bad even for the third family, since at M_X one finds $m_b = 0.6m_\tau$. This means that one must include higher dimensional

operators [47] in the Yukawa sector, up to now neglected. Alternatively, you can include other Higgs representations that can contribute to the fermionic masses; for example, you can add 45_H .

Now, besides the usual Yukawa structure of the Higgs doublet in the SM, one has new interactions of the color triplet h_α . From (65) and (66) it is easy to compute it's couplings to fermions

$$\mathcal{L}_h = f_d \bar{\psi}_{Ri} \chi^{i\alpha} h_\alpha^+ + f_u \epsilon_{ijkl\alpha} (\chi^T)^{ij} C \chi^{kl} h^\alpha \quad (68)$$

which gives

$$\begin{aligned} \mathcal{L}_h = & \{ f_d (\epsilon^{\alpha\beta\gamma} \bar{u}_{L\beta}^c d_R^\gamma + \bar{u}_L^\alpha e_R^+ + \bar{d}_L^\alpha \nu_R^c) \\ & + f_u (\epsilon^{\alpha\beta\gamma} \bar{u}_{R\beta}^c d_L^\gamma + \bar{u}_R^\alpha e_L^+) \} h^\alpha \end{aligned} \quad (69)$$

Notice that the structure of the above couplings (not the strength, though), is dictated by the $SU(3)_C \times SU(2)_L \times U(1)_Y$ gauge invariance only. This becomes more clear if we write $\bar{u}_L^c d_R = \bar{u}_R^T C d_R$ and $\bar{u}_R^c d_L = \bar{u}_L^T C d_L$.

It is clear that the interactions of H break B and L , just like those of X and Y . Notice, though, that $B-L$ is again conserved. In a complete analogy with the situation encountered before for the X and Y bosons, we have the possible exchanges of h^α which leads to the proton decay. Of course, the amplitude is proportional to small Yukawa couplings and the corresponding limit on its mass is somewhat less strict: $m_h \gtrsim 10^{12} GeV$.

5.3.1 Generations and their mixings

We know that in the standard model the neutral current interactions are flavor diagonal and that the charged current processes lead to flavor mixing and CP violation. How is this feature incorporated in the $SU(5)$ theory and what about new superweak interactions of the X and Y bosons? The analysis is straightforward and it proceeds along the same lines as in the $SU(2)_L \times U(1)_Y$ theory [36]. I should stress that the predictions we will obtain are of course not realistic since in this minimal theory neutrinos are massless and the down quark and charged lepton mass relations come out wrong. The minimal model discussed here should be viewed only as a prototype of the what predictive theory should be like.

We diagonalize as usual fermion mass matrices by bi-unitary transformations

$$\mathcal{U}_{L_f}^\dagger M_f \mathcal{U}_{R_f} = D_f \quad (70)$$

where D_f is diagonal, with its elements being real, positive numbers. Furthermore, since M_u is symmetric

$$\mathcal{U}_{Ru} = \mathcal{U}_{Lu}^* K^* \quad (71)$$

where

$$K = \begin{pmatrix} e^{i\phi_u} & & & \\ & e^{i\phi_e} & & \\ & & e^{i\phi_t} & \\ & & & \dots \end{pmatrix} \quad (72)$$

is the matrix of phases needed to ensure that the elements of D_u are real and positive. The above statements are equivalent to the redefinition of our original fermionic fields in the Lagrangian

$$f_{L,R} \rightarrow \mathcal{U}_{L,R}^\dagger f_{L,R} \quad (73)$$

with $\mathcal{U}_{L,R}^d = \mathcal{U}_{L,R}^{e^+}$. Since on the other hand the neutrinos are massless, we can rotate them any which way we wish and so we chose $\nu_R^c \rightarrow \mathcal{U}_R^d \nu_R^c$. Thus we can write for the 5-dimensional representation $\psi_R \rightarrow \mathcal{U}_R^d \psi_R$, which means that \mathcal{U}_R^d disappears since it is just an overall factor. Suppressing the color index, we can write

$$\begin{aligned} \chi &\rightarrow \begin{bmatrix} \mathcal{U}_{Lu} K u^c & -\mathcal{U}_{Lu} u & -\mathcal{U}_{Ld} d \\ & & -\mathcal{U}_{Ld} e^+ \end{bmatrix}_L \\ &= \mathcal{U}_{Ld} \begin{bmatrix} \mathcal{U}_{CKM} K u^c & -\mathcal{U}_{CKM} u & -d \\ & & -e^+ \end{bmatrix}_L \end{aligned} \quad (74)$$

where $\mathcal{U}_{CKM} = \mathcal{U}_{Ld}^\dagger \mathcal{U}_{Lu}$. Although I use the CKM notation, this matrix has in general extra quark phases that one rotates away in the SM interactions of the W boson. Again \mathcal{U}_{Ld} is just an overall factor and so it will disappear. Thus, the X and Y boson interactions involve *no* new flavor mixings besides \mathcal{U}_{CKM} , only new phases. This was coined the ‘kinship’ hypothesis by Wilczek and Zee [37], and in the minimal SU(5) it is unfortunately the consequence of wrong mass relations $m_d = m_\ell$. In the physical basis we get

$$\begin{aligned} \mathcal{L}(X, Y) &= \frac{g}{\sqrt{2}} \bar{X}_\mu \left[\bar{d}_R \gamma^\mu e_R^+ + \bar{d}_L \gamma^\mu e_L^+ + \bar{u}_L^c \gamma^\mu K^* u_L \right] \\ &+ \frac{g}{\sqrt{2}} \bar{Y}_\mu \left[-\bar{d}_R \gamma^\mu \nu_R^c + \bar{u}_L \gamma^\mu \mathcal{U}_{CKM}^\dagger e_L^+ + \bar{u}_L^c \gamma^\mu \mathcal{U}_{CKM}^\dagger d_L \right] + h.c. \end{aligned} \quad (75)$$

From $\mathcal{U}_{11} \propto \cos \theta_c$, $\mathcal{U}_{12} \propto \sin \theta_c$ we would expect

$$\frac{\Gamma(p \rightarrow \pi^0 \mu^+)}{\Gamma(p \rightarrow \pi^0 e^+)} \propto \sin^2 \theta_c \quad (76)$$

Of course, this minimal $SU(5)$ model is not realistic, for down and strange quark masses are not equal to their leptonic counterparts at the unification scale. It is only an illustration how proton decay partial rates are connected to the fermion masses and mixings. The true test can only be possible in a completely realistic grand unified theory of fermion masses and mixings.

In any case, the minimal $SU(5)$ theory fails to explain neutrino masses; it is custom fit for massless neutrinos. While non-minimal models can lead to non-vanishing neutrino masses, by itself, $SU(5)$ just like the standard model cannot relate neutrino masses to charged fermion masses nor relate quark and lepton mixing angles. This is cured beautifully in the $SO(10)$ theory which requires the existence of right-handed neutrinos and leads to small, non-vanishing neutrino masses through the see-saw mechanism. The main ingredients are the left-right and quark-lepton symmetry inbuilt in $SO(10)$ automatically. However, $SU(5)$ offers an interesting possibility of neutrino Yukawa couplings be probed at LHC and before moving to $SO(10)$ in Section 6 we will discuss a simple and predictive $SU(5)$ theory with an adjoint fermionic representation added to the minimal model discussed above. We will show that the theory is completely realistic and testable at colliders.

5.4 Low energy predictions

5.4.1 Ordinary $SU(5)$

I discuss here some elementary and simple aspects of gauge coupling unification, at the one loop level. As is well known, the couplings run logarithmically with energy. We have

$$\frac{1}{\alpha_G(M_W)} = \frac{1}{\alpha_U} - \frac{1}{2\pi} b_G \ln \frac{M_X}{M_W} \quad (77)$$

for the gauge group G ; M_X is the energy where we imagine the unification to take place, and α_U is the value of the unified coupling at M_X . One has a generic formula for the running coefficient

$$b_G = \frac{11}{3} T_{GB} - \frac{2}{3} T_F - \frac{1}{3} T_H \quad (78)$$

where the Casimir T_R for the representation R is defined by

$$T_R \delta_{ij} = Tr T_i T_j \quad (79)$$

and T_i are the Hermitian traceless generators of a group in question. For the fundamental representation of $SU(N)$ the convention is the one of $SU(2)$:

$T_{fund} = \frac{1}{2}$, which implies for the adjoint representation (relevant for gauge bosons) in $SU(N)$: $T_{adj} = T_{GB} = N$.

Exercise:

Prove the above claim: $T_{adj} = T_{GB} = N$ for the adjoint of $SU(N)$ using $T_{fund} = \frac{1}{2}$.

This gives for the $SU(3)_C$, $SU(2)_L$ and $U(1)$ respectively

$$\begin{aligned} b_3 &= \frac{33}{3} - \frac{4}{3}n_g \\ b_2 &= \frac{22}{3} - \frac{4}{3}n_g - \frac{1}{6}n_H \\ b_1 &= \frac{3}{5}b_Y = -\frac{4}{3}n_g - \frac{1}{10}n_H \end{aligned} \quad (80)$$

where N_g is the number of generations, n_H is the number of Higgs doublets ($n_H = 1$ in the minimal standard model).

We are now fully armed to check the evolution of these couplings above M_W . Using $\alpha_1(M_X) = \alpha_2(M_X) = \alpha_3(M_X) = \alpha_U$, we get

$$\frac{1}{\alpha_i(M_W)} - \frac{1}{\alpha_j(M_W)} = \frac{b_j - b_i}{2\pi} \ln \frac{M_X}{M_W} \quad (81)$$

From $\alpha_{em} = \sin^2 \theta_W \alpha_2 = \cos^2 \theta_W \alpha_Y$ and $\alpha_Y = 3/5\alpha_1$ we get easily

$$\begin{aligned} \frac{1}{\alpha_2(M_W)} - \frac{1}{\alpha_3(M_W)} &= \frac{22 + n_H}{12\pi} \ln \frac{M_X}{M_W} \\ \sin^2 \theta_W(M_W) &= \frac{3}{8} - \frac{110 - n_H}{48\pi} \alpha_{em}(M_W) \ln \frac{M_X}{M_W} \end{aligned} \quad (82)$$

Notice the prediction $\sin^2 \theta_W = \frac{3}{8}$ at M_X which we discussed before. Now, for $n_H = 1$ and by taking a $\alpha_3(M_W) \simeq .12$, $\alpha_2(M_W) \simeq 1/30$ we find $M_X \simeq 10^{16} GeV$, but

$$\sin^2 \theta_W(M_W) \simeq 0.2 \quad (83)$$

The minimal $SU(5)$ theory thus fails to meet the experiment.

5.4.2 Supersymmetric $SU(5)$

Supersymmetry, i.e. symmetry between bosons and fermions guarantees the cancellation of quadratic divergences for the Higgs mass and thus can make M_W insensitive to M_X . That is, we do not know why M_W/M_X is small, but it

is not a problem, since it will stay small in perturbation theory as long as the scale of supersymmetry breaking is small $\Lambda_{SS} \simeq M_W$. The point is that the Higgs mass term is invariant under the internal symmetries and thus is normally not protected from high scales as manifested by quadratic divergences. The fermion masses, on the other hand, are protected by chiral symmetry and thus insensitive to large scales as manifested by 'small' logarithmic divergences. In supersymmetry scalars and fermions are not distinguishable and thus Higgs mass is under control too.

Then for every particle of the standard model there is a supersymmetric partner of the opposite statistics

$$\begin{array}{ccc}
\text{FERMIONS} & \iff & \text{SFERMIONS} \\
(\text{quarks, leptons}) & & (\text{squarks, sleptons}) \\
s = 1/2 & & s = 0 \\
\\
\text{GAUGE BOSONS} & \iff & \text{GAUGINOS} \\
(W^\pm, Z, \gamma, \text{gluons}) & & (\text{Wino, Zino, photino, gluinos}) \\
s = 1 & & s = 1/2 \\
\\
\text{HIGGS SCALAR} & \iff & \text{HIGGSINO} \\
s = 0 & & s = 1/2
\end{array}$$

It is easy to see that the formulas for the running of the gauge couplings will be affected by the presence of the new particles. From (78) we get

$$b_G^{SS} = \left(\frac{11}{3} - \frac{2}{3}\right) T_{GB} - \left(\frac{2}{3} + \frac{1}{3}\right) T_F - \left(\frac{1}{3} + \frac{2}{3}\right) T_H \quad (84)$$

or

$$b_G = 3T_{GB} - T_F - T_H \quad (85)$$

where the added contributions in (84) are due to the superpartners. From (85) we get for the individual gauge couplings

$$\begin{aligned}
b_3^{SS} &= 9 - 2n_g \\
b_2^{SS} &= 6 - 2n_g - \frac{1}{2}n_H \\
b_1^{SS} &= -2n_g - \frac{3}{10}n_H
\end{aligned} \quad (86)$$

where n_H is again the number of Higgs doublets.

In exactly the same way as before, assuming the unification of couplings at M_X , we find [38]

$$\begin{aligned}\frac{1}{\alpha_2(M_W)} - \frac{1}{\alpha_3(M_W)} &= \frac{6 + n_H}{4\pi} \ln \frac{M_X}{M_W} \\ \sin^2 \theta_W(M_W) &= \frac{3}{8} - \frac{30 - n_H}{16\pi} \alpha_{em}(M_W) \ln \frac{M_X}{M_W}\end{aligned}\quad (87)$$

In the minimal supersymmetric standard model (MSSM) $n_H = 2$, and so [?] [?] [?]

$$M_X \simeq 10^{16} GeV \quad (88)$$

and

$$\sin^2 \theta_W(M_W) = \frac{1}{5} + \frac{7}{15} \frac{\alpha_{em}(M_W)}{\alpha_3(M_W)} \simeq 0.23 \quad (89)$$

MSSM agrees perfectly well with the experiment and with the above value for M_X we predict the proton lifetime

$$\tau_p \simeq 10^{35} yr \quad (90)$$

which is above the experimental bound (for the mode $p \rightarrow \pi^0 e^+$) [42]

$$(\tau_p)_{\text{exp}} \geq 8 \times 10^{33} yr \quad (91)$$

It actually did even better: the prediction of $\sin^2 \theta_W = 0.23$ was tied to the prediction of the heavy top quark, with $m_t \simeq 200 GeV$. Namely, in 1981 the low indirect measurements gave $\sin^2 \theta_W = 0.21$, with the assumed value $\rho = 1$. In order to make a case for low energy supersymmetry, Marciano and I [41] had to say that ρ was bigger, which required loops, which required at least one large coupling, and the only SM candidate was the top quark, with $y_t \simeq 1$. It is remarkable that both the $\sin^2 \theta_W = 0.23$ and the heavy top would turn out to be true.

Now, if we are to take supersymmetry seriously, all the way up to the scale M_X , we expect of course new gauginos \tilde{X}, \tilde{Y} , associated with the superheavy bosons X and Y of $SU(5)$; and also heavy Higgsinos \tilde{h}_α from $\mathbf{5}$ of $SU(5)$. The exchange of the heavy Higgsinos leads to proton decay, suppressed only linearly by the GUT scale [43]. More precisely, the exchange of heavy Higgsinos gives the effective operator $d = 5$ proton decay operator of the type

$$\frac{1}{M_T} QL\tilde{Q}\tilde{Q} \quad (92)$$

where Q and L stand for quarks and leptons and \tilde{Q} stands for squarks while M_T is the mass of the heavy color triplet Higgsino. In turn the squarks are changed into quarks through the exchange of gauginos and one obtains an operator of the form $QQQL$ of the proton decay.

A rough estimate gives

$$G_T \simeq \frac{\alpha}{4\pi} y_u y_d \frac{m_{\text{gaugino}}}{M_T m_{\tilde{f}}^2} \simeq 10^{-30} \text{ GeV}^{-2}$$

which for $y_u \simeq y_d \simeq 10^{-4}$, $m_{\text{gaugino}} \simeq 100 \text{ GeV}$, $m_{\tilde{f}} \simeq \text{TeV}$ and $M_T \simeq 10^{16} \text{ GeV}$ gives $\tau_p(d=5) \simeq 10^{30-31} \text{ yr}$. It would seem that today this theory is ruled out. It was actually proclaimed dead in 2001 when the triplet mass was carefully computed to give $M_T^0 = 3 \times 10^{15} \text{ GeV}$ [44] (for the superscript 0 explanation, see below). Caution must be raised however for two important reasons: i) the uncertainty in sfermion masses and mixings [45] and ii) uncertainty in M_T [46] due to necessity of higher dimensional operators [47] to correct bad fermion mass relations $m_d = m_\ell$ [48]. The $d=4$ operators, besides correcting these relations also split the masses m_3 and m_8 of weak triplet and color octet, respectively, in the adjoint 24_H Higgs super multiplet and one gets

$$\left. \begin{aligned} M_{GUT} &= M_{GUT}^0 \left(\frac{M_{GUT}^0}{2m_8} \right)^{1/2} \\ M_T &= M_T^0 \left(\frac{m_3}{m_8} \right)^{5/2} \end{aligned} \right\} \begin{aligned} M_{GUT}^0 &\simeq 10^{16} \text{ GeV} \\ M_T^0 &= 3 \times 10^{15} \text{ GeV} \end{aligned}$$

where the superscript 0 denotes the predictions for $m_3 = m_8$ at the tree level with $d=5$ operators neglected. The fact that M_{GUT} goes up with m_8 below M_{GUT} was noticed quite some time ago [49]. Imagine that $d=4$ terms dominate for small cubic Yukawa self coupling, in which case one has $m_3 = 4m_8$ and thus $M_T = 32M_T^0 \simeq 10^{17} \text{ GeV} \simeq M_{GUT}$ ($m_8 \simeq 10^{15} \text{ GeV}$). In turn a strong suppression of proton decay with $\tau_p \simeq 10^3 \tau_p^0(d=5) \simeq 10^{33-34} \text{ yr}$. In principle the ratio of the triplet and octet masses can be as large as one wishes, so at first glance the proton lifetime would seem not to be limited from above at all. However, all this makes sense if the theory remains perturbative and thus predictive. Increasing M_{GUT} would bring it too close to the Planck scale, so it is fair to conclude that the proton lifetime is below 10^{35} yr .

5.5 SU(5) and neutrino mass

The minimal theory of Georgi and Glashow fails in two crucial ways:

- a) it predicts massless neutrinos
- b) gauge couplings do not unify

We need a minimal extension that cures both problems. It does not suffice to add right-handed neutrinos for they are gauge singlets and do not contribute to the running of gauge couplings and thus cannot help the unification. In other words type I seesaw fails in minimal SU(5). One could try type II, which requires a 15-dimensional Higgs representation, but instead I wish to discuss here a particularly simple and predictive theory [50], since it only requires adding the adjoint fermions 24_F to the existing minimal model with three generations of quarks and leptons, and 24_H and 5_H Higgs fields. This automatically leads to the hybrid scenario of both type I and type III seesaw, since 24_F has also a SM singlet fermion, i.e. the right-handed neutrino. This should be clear to the alert student. After all, the 24_F is completely analogous to the 24_F or even better the adjoint gauge boson representation, which we studied at length. The fermionic triplet simply corresponds to the SU(2) gauge boson triplet, whereas the singlet corresponds to the U(1) gauge boson. This singlet can be interpreted as a right handed neutrino, for it is a SM neutral particle with Yukawa couplings to the light neutrinos. The triplet fermion on the other hand has the quantum numbers of the winos, the supersymmetric partners of the SU(2) charged and neutral gauge bosons.

The main prediction of this theory is the lightness of the fermionic triplet. For a conventional value of $M_{GUT} \approx 10^{16}$ GeV, the unification constraints strongly suggest its mass below TeV, relevant for the future colliders such as LHC. The triplet fermion decay predominantly into W (or Z) and leptons, with lifetimes shorter than about 10^{-12} sec.

Equally important, the decays of the triplet are dictated by the same Yukawa couplings that lead to neutrino masses and thus one has an example of predicted low-energy seesaw directly testable at colliders and likely already at LHC.

The minimal implementation of the type III seesaw in non-supersymmetric SU(5) requires a fermionic adjoint 24_F in addition to the usual field content 24_H , 5_H and three generations of fermionic 10_F and $\bar{5}_F$. The consistency of the charged fermion masses requires higher dimensional operators in the usual Yukawa sector [47]. One must add new Yukawa interactions

$$\begin{aligned} \mathcal{L}_{Y\nu} &= y_0^i \bar{5}_F^i 24_F 5_H \\ &+ \frac{1}{\Lambda} \bar{5}_F^i [y_1^i 24_F 24_H + y_2^i 24_H 24_F + y_3^i Tr(24_F 24_H)] 5_H + h.c. . \end{aligned} \quad (93)$$

After the SU(5) breaking one obtains the following physical relevant Yukawa interactions for neutrino with the triplet $T_F \equiv \vec{T}_F \cdot \vec{\sigma}$ and singlet S_F fermions

(together with mass terms for T_F and S_F)

$$\mathcal{L}_{Y\nu} = L_i (y_T^i T_F + y_S^i S_F) H + \frac{m_S}{2} S_F S_F + \frac{m_T}{2} T_F T_F + h.c. \quad (94)$$

where y_T^i, y_S^i are two different linear combinations of y_0^i and $y_a^i v_{GUT}/\Lambda$ ($a = 1, 2, 3$), L_i are the lepton doublets and H is the Higgs doublet. It is clear from the above formula that besides the new appearance of the triplet fermion, the singlet fermion in 24_F acts precisely as the right-handed neutrino; it should not come out as a surprise, as it has the right SM quantum numbers.

After the $SU(2) \times U(1)$ symmetry breaking ($\langle H \rangle = v \approx 174 \text{ GeV}$), one obtains in the usual manner the light neutrino mass matrix upon integrating out S_F and T_F

$$m_\nu^{ij} = v^2 \left(\frac{y_T^i y_T^j}{m_T} + \frac{y_S^i y_S^j}{m_S} \right) \quad (95)$$

with $m_T \leq 1 \text{ TeV}$ (see below) and m_S undetermined.

From the above formula, one important prediction emerges immediately: only two light neutrinos get mass, while the third one remains massless. This is understood readily. First, the Yukawas here are vectors, and for example the vector coupling corresponding to the triplet can be rotated in the say 3rd direction. Thus only one light neutrino effectively coupled to the triplet, i.e. only one neutrino gets the mass through this coupling. Obviously, the same could have been said about the singlet and thus only two massive light neutrinos. This is of course independent of the nature of the heavy states, and the number of light massive neutrinos is in direct proportion to the number of heavy fermions, be they singlets or triplets.

The mass of the fermionic triplet is found by performing the renormalization group analysis as before. From [50] one has

$$\exp [30\pi (\alpha_1^{-1} - \alpha_2^{-1}) (M_Z)] = \quad (96)$$

$$\left(\frac{M_{GUT}}{M_Z} \right)^{84} \left(\frac{(m_3^F)^4 m_3^B}{M_Z^5} \right)^5 \left(\frac{M_{GUT}}{m_{(3,2)}^F} \right)^{20} \left(\frac{M_{GUT}}{m_T} \right),$$

$$\exp [20\pi (\alpha_1^{-1} - \alpha_3^{-1}) (M_Z)] = \quad (97)$$

$$\left(\frac{M_{GUT}}{M_Z} \right)^{86} \left(\frac{(m_8^F)^4 m_8^B}{M_Z^5} \right)^5 \left(\frac{M_{GUT}}{m_{(3,2)}^F} \right)^{20} \left(\frac{M_{GUT}}{m_T} \right)^{-1},$$

where $m_3^{F,B}, m_8^{F,B}, m_{(3,2)}^F$ and m_T are the masses of weak triplets, color octets, (only fermionic) leptoquarks and (only bosonic) color triplets respectively.

We discussed at length the well known problem in the standard model of the low meeting scale of α_1 and α_2 . It is clear that the SU(2) triplet fermions are ideal from this point of view since they slow down the running of α_2 , while leaving α_1 intact (other particles have non vanishing hypercharge and thus make α_1 grow faster as to meet α_2 even before). They should clearly be as light as possible while the color triplet as heavy as possible. In order to illustrate the point, take $m_3^F = m_3^B = M_Z$ and $m_T = M_{GUT}$. This gives ($\alpha_1^{-1}(M_Z) = 59$, $\alpha_2^{-1}(M_Z) = 29.57$, $\alpha_3^{-1}(M_Z) = 8.55$) $M_{GUT} \approx 10^{15.5}$ GeV. Increasing the triplet masses $m_3^{F,B}$ reduces M_{GUT} dangerously, making proton decay too fast.

Finally, one can ask, where must the octets be. Since the triplets slowed down the running of α_2 , the meeting point of α_2 and α_3 would become too large, unless α_3 gets slowed down too. Thus the octets must lie much below M_{GUT} , but since they contribute to the running more than the triplets, they should be also much above the weak scale, and one gets $m_8 = 10^7 - 10^8$ GeV

For a more detailed discussion of unification constraints and the physics of the triplets, see [51], and for phenomenology of the triplet relevant for colliders, see [52]. The bottom line is a prediction of the light weak fermion triplet

$$m_T \leq TeV \quad (98)$$

Its decays proceed via its Yukawa couplings y_T and thus probe the neutrino mass. One can parametrize y_T through the lepton mixing matrix [53].

In normal hierarchy (NH) i.e. $m_1^\nu = 0$,

$$vy_T^{i*} = i\sqrt{m_T} \left(U_{i2}\sqrt{m_2^\nu} \cos z \pm U_{i3}\sqrt{m_3^\nu} \sin z \right) , \quad (99)$$

while in inverted hierarchy (IH) i.e. $m_3^\nu = 0$,

$$vy_T^{i*} = i\sqrt{m_T} \left(U_{i1}\sqrt{m_1^\nu} \cos z \pm U_{i2}\sqrt{m_2^\nu} \sin z \right) . \quad (100)$$

where z is a complex parameter.

You can readily show that in NH the neutrino masses are

$$m_1^\nu = 0 \quad , \quad m_2^\nu = \sqrt{\Delta m_S^2} \quad , \quad m_3^\nu = \sqrt{\Delta m_A^2 + \Delta m_S^2} \quad , \quad (101)$$

while in the IH case

$$m_1^\nu = \sqrt{\Delta m_A^2 - \Delta m_S^2} \quad , \quad m_2^\nu = \sqrt{\Delta m_A^2} \quad , \quad m_3^\nu = 0 \quad . \quad (102)$$

The the predominant decay modes of the triplets [51] are $T \rightarrow W(Z) +$ light lepton whose strength is dictated by the neutral Dirac Yukawa couplings.

$$\Gamma(T^- \rightarrow Z e_k^-) = \frac{m_T}{32\pi} |y_T^k|^2 \left(1 - \frac{m_Z^2}{m_T^2}\right)^2 \left(1 + 2\frac{m_Z^2}{m_T^2}\right), \quad (103)$$

$$\sum_k \Gamma(T^- \rightarrow W^- \nu_k) = \frac{m_T}{16\pi} \left(\sum_k |y_T^k|^2\right) \left(1 - \frac{m_W^2}{m_T^2}\right)^2 \left(1 + 2\frac{m_W^2}{m_T^2}\right) \quad (104)$$

$$\begin{aligned} \Gamma(T^0 \rightarrow W^+ e_k^-) &= \Gamma(T^0 \rightarrow W^- e_k^+) = \\ &= \frac{m_T}{32\pi} |y_T^k|^2 \left(1 - \frac{m_W^2}{m_T^2}\right)^2 \left(1 + 2\frac{m_W^2}{m_T^2}\right), \end{aligned} \quad (105)$$

$$\sum_k \Gamma(T^0 \rightarrow Z \nu_k) = \frac{m_T}{32\pi} \left(\sum_k |y_T^k|^2\right) \left(1 - \frac{m_Z^2}{m_T^2}\right)^2 \left(1 + 2\frac{m_Z^2}{m_T^2}\right) \quad (106)$$

where we averaged over initial polarizations and summed over final ones. From (105) one sees that the decays of T^0 , just as those of righthanded neutrinos, violate lepton number. In a machine such as LHC one would typically produce a pair T^+T^0 (or T^-T^0), whose decays then allow for interesting $\Delta L = 2$ signatures of same sign dileptons and 4 jets. This fairly SM background free signature is characteristic of any theory with righthanded neutrinos as discussed in [27]. The main point here is that these triplets are really predicted to be light, unlike in the case of righthanded neutrinos. We discuss this further in the Section 7 on lepton number violation.

6 SO(10): family unified

The minimal gauge group that unifies the gauge interactions of the standard model was seen in the previous subsection to be based on SU(5) and studied at length. It is tailor fit for massless neutrinos just as the SM, for in the minimal version of the theory neutrinos get neither Dirac nor Majorana mass terms. Furthermore, the ordinary, non supersymmetric theory fails to unify gauge couplings. We found that the simple extension with the adjoint fermion representation provides a minimal and remarkably predictive theory with light fermionic triplet expected at LHC and whose decay rates probe the Dirac Yukawa couplings of neutrinos. We have a theory that works and furthermore gives serious hope for an old dream of verifying seesaw mechanism at colliders. So why should one ever wish to go beyond SU(5)? We can think of at least two reasons. First, if one is to worry about the Higgs mass

naturalness, one may wish to include supersymmetry. While $SU(5)$ with the low energy supersymmetry has a rather appealing feature of providing automatically (as predicted many years ago) a gauge coupling unification, it is not an interesting theory of fermion masses and mixings. First of all, it offers no explanation for the smallness of R-parity violation in nature, and at the same time it requires a certain amount of arbitrary and unpredicted R-parity violation in order to provide neutrino masses. One can also include the type II seesaw into the theory through the 15_H supermultiplet, and even attribute to it a mediation of supersymmetry breaking [54], but one ends up without any direct low energy probes or interesting quark-lepton mass and mixings relations. This is where $SO(10)$ fits ideally, for it also unifies matter besides the interactions. It works nicely without supersymmetry too, for it provides a natural unification of gauge couplings through the intermediate scale of L-R symmetry breaking.

The general case $SO(2N)$ is presented in Appendix D. The one important representation of $SO(10)$ is a 16-dimensional spinor, which can be decomposed under $SU(5)$ as $16 = 10 + \bar{5} + 1$. It unifies a family of fermions with an addition of a right handed neutrino per family. This minimal grand unified theory that unifies matter on top of interactions suggests naturally small neutrino masses through the seesaw mechanism. Furthermore, it relates neutrino masses and mixings to the ones of charged fermions, and is predictive in its minimal version. In this Section I discuss some salient features in this theory while focusing on its minimal realizations. The crucial representation is a self-dual five index anti-symmetric one responsible for right-handed neutrino masses and is a must, whether being elementary or composed at the loop level or through the higher dimensional operators. A number of different minimal realizations of $SO(10)$ depends on this construction, and what follows summarizes a few of them.

There are a number of features that make $SO(10)$ special:

1. a family of fermions is unified in a 16-dimensional spinorial representation; this in turn predicts the existence of right-handed neutrinos
2. $L - R$ symmetry is a finite gauge transformation in the form of charge conjugation. This is a consequence of both left-handed fermions f_L and its charged conjugated counterparts $(f^c)_L \equiv C\bar{f}_R^T$ residing in the same representation 16_F .
3. in the supersymmetric version, matter parity $M = (-1)^{3(B-L)}$, equivalent to the R-parity $R = M(-1)^{2S}$, is a gauge transformation [55], a part of the center Z_4 of $SO(10)$. It simply reads $16 \rightarrow -16$, $10 \rightarrow 10$. Its fate depends then on the pattern of symmetry breaking (or the choice

of Higgs fields); it turns out that in the renormalizable version of the theory R-parity remains exact at all energies [56, 57]. The lightest supersymmetric partner (LSP) is then stable and is a natural candidate for the dark matter of the universe.

4. its other maximal subgroup, besides $SU(5) \times U(1)$, is $SO(4) \times SO(6) = SU(2)_L \times SU(2)_R \times SU(4)_c$ symmetry of Pati and Salam. It explains immediately the somewhat mysterious relations $m_d = m_e$ (or $m_d = 1/3m_e$) of $SU(5)$.
5. the unification of gauge couplings can be achieved with or without supersymmetry.
6. the minimal renormalizable version (with no higher dimensional $1/M_{Pl}$ terms) offers a simple and deep connection between $b - \tau$ unification and a large atmospheric mixing angle in the context of the type II see-saw [58] [59].

In order to understand some of these results, and in order to address the issue of construction of the theory, we turn now to the Yukawa sector.

6.1 Yukawa sector

Fermions belong to the spinor representation 16_F [60]. From

$$16 \times 16 = 10 + 120 + 126 \quad (107)$$

the most general Yukawa sector in general contains 10_H , 120_H and $\overline{126}_H$, respectively the fundamental vector representation, the three-index antisymmetric representation and the five-index antisymmetric and anti-self-dual representation. This can be seen by analogy with the Yukawa couplings of $SO(6)$ (see Appendix D)

$$\begin{aligned} \mathcal{L}_y &= y_{10} \Psi^T B \Gamma_i \Psi \Phi_i + y_{120} \Psi^T B \Gamma_i \Gamma_j \Gamma_k \Psi \Phi_{[ijk]} \\ &+ y_{126} \Psi^T B \Gamma_i \Gamma_j \Gamma_k \Gamma_l \Gamma_m \Psi \Phi_{[ijklm]}^- \end{aligned} \quad (108)$$

$\overline{126}_H$ is necessarily complex, supersymmetric or not; 10_H and $\overline{126}_H$ Yukawa matrices are symmetric in generation space, while the 120_H one is antisymmetric.

Understanding fermion masses is easier in the Pati-Salam language of one of the two maximal subgroups of $SO(10)$, $G_{PS} = SU(4)_c \times SU(2)_L \times SU(2)_R$ (the other being $SU(5) \times U(1)$). Let us decompose the relevant representations under G_{PS}

$$\begin{aligned}
\mathbf{16} &= (4, 2, 1) + (\bar{4}, 1, 2) \\
\mathbf{10} &= (1, 2, 2) + (6, 1, 1) \\
\mathbf{120} &= (1, 2, 2) + (6, 3, 1) + (6, 1, 3) + (15, 2, 2) + (10, 1, 1) + (\overline{10}, 1, 1) \\
\overline{\mathbf{126}} &= (\overline{10}, 3, 1) + (10, 1, 3) + (15, 2, 2) + (6, 1, 1)
\end{aligned} \tag{109}$$

I illustrate the decomposition of a spinor representation $16 = \Psi_+$ (see Appendix D)

$$\Psi_+ \equiv |\epsilon_1 \dots \epsilon_5\rangle; \quad \epsilon_1 \dots \epsilon_5 = +1 \tag{110}$$

It contains

$$\epsilon_1 \epsilon_2 \epsilon_3 = +1; \quad \epsilon_4 \epsilon_5 = +1 \tag{111}$$

and

$$\epsilon_1 \epsilon_2 \epsilon_3 = -1; \quad \epsilon_4 \epsilon_5 = -1 \tag{112}$$

The first one is 4 of $SU(4)_C$, doublet of $SU(2)_L$ and the latter $\bar{4}$ of 4 of $SU(4)_C$, doublet of $SU(2)_R$, as can be read off readily from the sections on $SO(4)$ and $SO(6)$ of Appendix D.

Exercise: *Try to arrive at the rest of the above decomposition using the material in Appendix D*

Clearly, the see-saw mechanism, whether type I or II, requires $\overline{126}$: it contains both $(10, 1, 3)$ whose vev gives a mass to ν_R (type I), and $(\overline{10}, 3, 1)$, which contains a color singlet, $B - L = 2$ field Δ_L , that can give directly a small mass to ν_L (type II). A reader familiar with the $SU(5)$ language sees this immediately from the decomposition under this group

$$\overline{\mathbf{126}} = 1 + 5 + 15 + \overline{45} + 50 \tag{113}$$

The 1 of $SU(5)$ belongs to the $(10, 1, 3)$ of G_{PS} and gives a mass for ν_R , while 15 corresponds to the $(\overline{10}, 3, 1)$ and gives the direct mass to ν_L .

Of course, $\overline{126}_H$ can be a fundamental field, or a composite of two $\overline{16}_H$ fields, or can even be induced as a two-loop effective representation built out of a 10_H and two gauge 45-dim representations. In what follows I shall discuss carefully all three possibilities.

Normally the light Higgs is chosen to be the smallest one, 10_H . Since $\langle 10_H \rangle = \langle (1, 2, 2) \rangle_{PS}$ is a $SU(4)_c$ singlet, $m_d = m_e$ follows immediately,

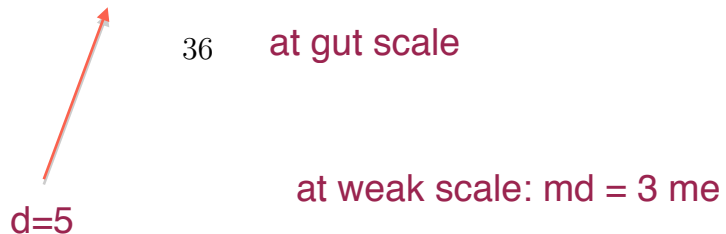

independently of the number of 10_H you wish to have. Thus we must add either 120_H or $\overline{126}_H$ or both in order to correct the bad mass relations. Both of these fields contain $(15, 2, 2)_{PS}$, and its vev gives the relation $m_e = -3m_d$.

As $\overline{126}_H$ is needed anyway for the see-saw, it is natural to take this first. The crucial point here is that in general $(1, 2, 2)$ and $(15, 2, 2)$ mix through $\langle(10, 1, 3)\rangle$ [61] and thus the light Higgs is a mixture of the two. In other words, $\langle(15, 2, 2)\rangle$ in $\overline{126}_H$ is in general non-vanishing¹. It is rather appealing that 10_H and $\overline{126}_H$ may be sufficient for all the fermion masses, with only two sets of symmetric Yukawa coupling matrices.

6.2 An instructive failure

Before proceeding, let me emphasize the crucial point of the necessity of 120_H or $\overline{126}_H$ in the charged fermion sector on an instructive failure: a simple and beautiful model by Witten [62]. The model is non-supersymmetric and the SUSY lovers may place the blame for the failure here. It uses $\langle 16_H \rangle$ in order to break $B - L$, and the "light" Higgs is 10_H . Witten noticed an ingenious and simple way of generating an effective mass for the right-handed neutrino, through a two-loop effect which gives

$$M_{\nu_R} \simeq y_{up} \left(\frac{\alpha}{\pi} \right)^2 M_{GUT} \quad (114)$$

where one takes all the large mass scales, together with $\langle 16_H \rangle$, of the order M_{GUT} . Since $\langle 10_H \rangle = \langle (1, 2, 2)_{PS} \rangle$ preserves quark-lepton symmetry, it is easy to see that

$$\begin{aligned} M_\nu &\propto M_u \\ M_e &= M_d \\ M_u &\propto M_d \end{aligned} \quad (115)$$

so that $V_{\text{lepton}} = V_{\text{quark}} = 1$. The model fails badly.

The original motivation here was a desire to know the scale of M_{ν_R} and increase M_ν , at that time neutrino masses were expected to be larger. But the real achievement of this simple, elegant, minimal SO(10) theory is the predictivity of the structure of M_{ν_R} and thus M_ν . It is an example of a good, albeit wrong theory: it fails because it predicts.

What is the moral behind the failure? Not easy to answer. The main problem, in my opinion, was to ignore the fact that with only 10_H already

¹In supersymmetry this is not automatic, but depends on the Higgs superfields needed to break SO(10) at M_{GUT} .

charged fermion masses fail. One needs to enlarge the Higgs sector, by adding for example a 120_H ; the theory still leads to interesting predictions while possible completely realistic [63] [64].

6.3 Non-supersymmetric $SO(10)$

In the last two decades, and especially after its success with gauge coupling unification, grand unification by an large got tied up with low energy supersymmetry. This is certainly well motivated, since supersymmetry is the only mechanism in field theory which controls the gauge hierarchy. In $SO(10)$, gauge coupling unification needs no supersymmetry whatsoever. It only says that there must be intermediate scales [65], such as Pati-Salam $SU(4)_c \times SU(2)_L \times SU(2)_R$ or Left-Right $SU(3)_c \times SU(2)_L \times SU(2)_R \times U(1)_{B-L}$ symmetry, between M_W and M_{GUT} . An oasis or two in the desert is always welcome.

Thus if we accept the fine-tuning, as we seem to be forced in the case of the cosmological constant, we can as well study the ordinary, non-supersymmetric version of the theory. In this context the idea of the cosmic attractors [66] as the solution to the gauge hierarchy becomes extremely appealing. It needs no supersymmetry whatsoever, and enhances the motivation for ordinary grand unified theories. In what follows I discuss some essential features of a possible minimal such theory with 126_H as a necessary ingredient for see-saw.

Let us start by analyzing the case with an extra 10_H field [67]. The most general Yukawa interaction is

$$\mathcal{L}_Y = 16_F (10_H Y_{10} + \overline{126}_H Y_{126}) \mathbf{16}_F + h.c. . \quad (116)$$

where Y_{10} and Y_{126} are symmetric matrices in the generation space. With this one obtains relations for the Dirac fermion masses

$$\begin{aligned} M_D &= M_1 + M_0 \quad , \quad M_U = c_1 M_1 + c_0 M_0 \quad , \\ M_E &= -3M_1 + M_0 \quad , \quad M_{\nu_D} = -3c_1 M_1 + c_0 M_0, \end{aligned} \quad (117)$$

where we have defined

$$M_1 = \langle 2, 2, 15 \rangle_{126}^d Y_{126} \quad , \quad M_0 = \langle 2, 2, 1 \rangle_{10}^d Y_{10} \quad , \quad (118)$$

and

$$c_0 = \frac{\langle 2, 2, 1 \rangle_{10}^u}{\langle 2, 2, 1 \rangle_{10}^d} \quad , \quad c_1 = \frac{\langle 2, 2, 15 \rangle_{126}^u}{\langle 2, 2, 15 \rangle_{126}^d} . \quad (119)$$

In the physically sensible approximation $\theta_q = V_{cb} = 0$, these relations imply

$$c_0 = \frac{m_c(m_\tau - m_b) - m_t(m_\mu - m_s)}{m_s m_\tau - m_\mu m_b} \approx \frac{m_t}{m_b}, \quad (120)$$

Exercise: *Derive this formula.*

Notice that this means that 10_H cannot be real, since in that case one would have $|\langle 2, 2, 1 \rangle_{10}^u| = |\langle 2, 2, 1 \rangle_{10}^d|$, implying m_t/m_b of order one. It is necessary to complexify 10_H , just as in a supersymmetric theory. If taking advantage of this fact one decides to impose a Peccei-Quinn symmetry, thus providing a Dark Matter candidate, the Yukawa sector in non-supersymmetric and supersymmetric models is similar.

In this case, this model has the interesting feature of automatic connection between $b - \tau$ unification and large atmospheric mixing angle in the type II see-saw. From $M_{\nu_L} \propto Y_{126}$, one has $M_{\nu_L} \propto M_D - M_E$, as shown in [58]. This fact has inspired the careful study of the analogous supersymmetric version where $m_\tau \simeq m_b$ at the GUT scale works rather well. In the non-supersymmetric theory, $b - \tau$ unification fails badly, $m_\tau \sim 2m_b$ [88]. The realistic theory will require a Type I seesaw, or an admixture of both possibilities.

Suppose now that we choose instead $\mathbf{120_H}$ [67]. Since Y_{120} is antisymmetric, this means only 3 new complex couplings on top of Y_{126} . One gets in this case

$$\begin{aligned} M_D &= M_1 + M_2 & , & & M_U &= c_1 M_1 + c_2 M_2 & , & & (121) \\ M_E &= -3M_1 + c_3 M_2 & , & & M_{\nu_D} &= -3c_1 M_1 + c_4 M_2 \end{aligned}$$

where M_1 and c_1 are defined in (118),(119), and:

$$\begin{aligned} M_2 &= Y_{120} (\langle 2, 2, 1 \rangle_{120}^d + \langle 2, 2, 15 \rangle_{120}^d) & , & & c_2 &= \frac{\langle 2, 2, 1 \rangle_{120}^u + \langle 2, 2, 15 \rangle_{120}^u}{\langle 2, 2, 1 \rangle_{120}^d + \langle 2, 2, 15 \rangle_{120}^d} , \\ c_3 &= \frac{\langle 2, 2, 1 \rangle_{120}^d - 3\langle 2, 2, 15 \rangle_{120}^d}{\langle 2, 2, 1 \rangle_{120}^d + \langle 2, 2, 15 \rangle_{120}^d} & , & & c_4 &= \frac{\langle 2, 2, 1 \rangle_{120}^u - 3\langle 2, 2, 15 \rangle_{120}^u}{\langle 2, 2, 1 \rangle_{120}^d + \langle 2, 2, 15 \rangle_{120}^d} \end{aligned}$$

It is easy to see that again there is a need to complexify the Higgs fields, by arguments similar to the case of 10_H .

In order to obtain algebraic expressions, from which a clearer physical meaning can be extracted, one can restrict the analysis to the second and third generations. Later, numerical studies could include the effects of the first generation as a perturbation. In the basis where M_1 is diagonal, real

and non-negative, for the two-generation case one gets:

$$M_1 \propto \begin{pmatrix} \sin^2 \theta & 0 \\ 0 & \cos^2 \theta \end{pmatrix} \quad (123)$$

and the most general charged fermion matrix can be written as:

$$M_f = \mu_f \begin{pmatrix} \sin^2 \theta & i(\sin \theta \cos \theta + \epsilon_f) \\ -i(\sin \theta \cos \theta + \epsilon_f) & \cos^2 \theta \end{pmatrix}, \quad (124)$$

where $f = D, U, E$ stands for charged fermions and ϵ_f vanishes for negligible second generation masses. In other words $|\epsilon_f| \propto m_2^f/m_3^f$. Furthermore the real parameter μ_f sets the third generation mass scale. By calculating up to leading order in $|\epsilon_f|$, we have to the following interesting predictions [67]:

1. type I and type II seesaw lead to the same structure

$$M_N^I \propto M_N^{II} \propto M_1 \quad (125)$$

so that in the selected basis the neutrino mass matrix is diagonal. We see that the angle θ has to be identified with the leptonic (atmospheric) mixing angle θ_A up to terms of the order of $|\epsilon_E| \approx m_\mu/m_\tau$. For the neutrino masses we obtain from (123)

$$\frac{m_3^2 - m_2^2}{m_3^2 + m_2^2} = \frac{\cos 2\theta_A}{1 - \sin^2 2\theta_A/2} + \mathcal{O}(|\epsilon|) \quad (126)$$

Exercise: *Derive this formula.*

This equation points to an intriguing correlation: the degeneracy of neutrino masses is measured by the maximality of the atmospheric mixing angle.

2. the ratio of tau and bottom mass at the GUT scale is given by:

$$\frac{m_\tau}{m_b} = 3 + \mathcal{O}(|\epsilon|) \quad (127)$$

This is not correct in principle, the extrapolation in standard model gives $m_\tau \approx 2m_b$. However, several effects modify this conclusion, such as for example the inclusion of the first generation or the running of Yukawa couplings. We would in any case expect that m_b comes out as small as possible.

3. the quark mixing is found to be:

$$|V_{cb}| = |\cos 2\theta_A (\epsilon_D - \epsilon_U)| + \mathcal{O}(|\epsilon^2|) \quad (128)$$

This equation demonstrates the successful coexistence of small and large mixing angles. In order for it to work quantitatively, $|\cos 2\theta_A|$ should be as large as possible, i.e. θ_A should be as far as possible from the maximal value 45° . To make a definite numerical statement, again, the effects from the first generation and the loops have to be included.

6.4 Supersymmetric case

In supersymmetry 10_H is necessarily complex and the bidoublet $(1, 2, 2)$ in 10_H contains the two Higgs doublets of the MSSM, with the vevs v^u and v^d in general different: $\tan \beta \equiv v^u/v^d \neq 1$ in general. In order to study the physics of $SO(10)$, we need to know what the theory is, i.e. its Higgs content. There are two orthogonal approaches to the issue, as we discuss now.

Small representations. The idea: take the smallest Higgs fields (least number of fields, not of representations) that can break $SO(10)$ down to the MSSM and give realistic fermion masses and mixings. The following fields are both necessary and sufficient

$$45_H, 16_H + \overline{16}_H, 10_H \quad (129)$$

It all looks simple and easy to deal with, but the superpotential becomes extremely complicated. First, at the renormalizable level it is too simple. The pure Higgs and the Yukawa superpotential at the renormalizable level take the form

$$W_H = m_{45} 45_H^2 + m_{16} 16_H \overline{16}_H + \lambda_1 16_H \Gamma^2 \overline{16}_H 45_H \\ m_{10} 10_H^2 + \lambda_2 16_H \Gamma 16_F 10_H + \lambda_3 \overline{16}_H \Gamma \overline{16}_H 10_H \quad (130)$$

$$W_y = y_{10} 16_F \Gamma 16_F 10_H \quad (131)$$

where Γ stands for the Clifford algebra matrices of $SO(10)$, $\Gamma_1 \dots \Gamma_{10}$, and the products of Γ 's are written in a symbolic notation (both internal and Lorentz charge conjugation are omitted).

Clearly, both W_H and W_y are insufficient. The fermion mass matrices would be completely unrealistic and the vevs $\langle 45_H \rangle, \langle 6_H \rangle, \langle \overline{16}_H \rangle$ would all point in the $SU(5)$ direction. Thus, one adds non-renormalizable operators

$$\Delta W_H = \frac{1}{M_{Pl}} [(45_H^2)^2 + 45_H^4 + (16_H \overline{16}_H)^2 + (16_H \Gamma^2 \overline{16}_H)^2 + (16_H \Gamma^4 \overline{16}_H)^2 \\ + (16_H \Gamma 16_H)^2 + (16_H \Gamma^5 16_H)^2 + \{16_H \rightarrow \overline{16}_H\} \\ + 16_H \Gamma^4 \overline{16}_H 45_H^2 + 16_H \Gamma^3 \overline{16}_H 45_H 10_H + \{16_H \rightarrow \overline{16}_H\}] \quad (132)$$

$$\Delta W_y = \frac{1}{M_{Pl}} \left[16_F \Gamma 16_F 16_H \Gamma 16_H + \{16_H \rightarrow \overline{16}_H\} \right. \\ \left. 16_F \Gamma^3 16_F 45_H 10_H + 16_F \Gamma^5 16_F \overline{16}_H \Gamma^5 \overline{16}_H \right] \quad (133)$$

where I take for simplicity all the couplings to be unity; there are simply too many of them. The large number of Yukawa couplings means very little predictivity.

The way out is to add flavor symmetries and to play the texture game and thus reduce the number of couplings. This in a sense goes beyond grand unification and appeals to new physics at M_{Pl} and/or new symmetries.

To me, maybe the least appealing aspect of this approach is the loss of R (matter) parity due to 16_H and $\overline{16}_H$; it must be postulated by hand as much as in the MSSM.

On the positive side, it is an asymptotically free theory and one can work in the perturbative regime all the way up to M_{Pl} . While this sounds nice, I am not sure what it means in practice. It would be crucial if you were able to make high precision determination of M_{GUT} or m_T , the mass of colored triplets responsible for $d = 5$ proton decay. The trouble is that the lack of knowledge of the superpotential couplings is sufficient even in the minimal SU(5) theory to prevent this task; in SO(10) it gets even worse.

Maybe more relevant is the fact that in this scenario $M_R \simeq M_{GUT}^2/M_{Pl} \simeq 10^{13} - 10^{14} GeV$, which fits nicely with the neutrino masses via see-saw. Furthermore, see-saw can be considered "clean", of the pure type I, since the type II effect is suppressed by $1/M_{Pl}$. Most important, the $m_b \simeq m_\tau$ relation from (131) is maintained due to small $1/M_{Pl}$ effects relevant only for the first two generations.

Large representations The non-renormalizable operators in reality mean invoking new physics beyond grand unification. This may be necessary, but still, one should be more ambitious and try to use the renormalizable theory only. This means large representations necessarily: at least $\overline{126}_H$ is needed in order to give the mass to ν_R (in supersymmetry, one must add 126_H). The consequence is the loss of asymptotic freedom above M_{GUT} , the coupling constants grow large at the scale $\Lambda_F \simeq 10M_{GUT}$.

Once we accept large representations, we should minimize their number. The minimal theory contains, on top of 10_H , 126_H and $\overline{126}_H$, also 210_H [68, 69, 70, 71] with the decomposition

$$210_H = (1, 1, 1)_- + (15, 1, 1)_+ + (15, 1, 3) + (15, 3, 1) \\ + (6, 2, 2) + (10, 2, 2) + (\overline{10}, 2, 2) \quad (134)$$

where the $-(+)$ subscript denotes the properties of the color singlets under charge conjugation.

The Higgs superpotential is remarkably simple

$$W_H = m_{210}(210_H)^2 + m_{126}\overline{126}_H 126_H + m_{10}(10_H)^2 + \lambda(210_H)^3 \\ + \eta 126_H \overline{126}_H 210_H + \alpha 10_H 126_H 210_H + \bar{\alpha} 10_H \overline{126}_H 210_H \quad (135)$$

and the Yukawa one even simpler

$$W_Y = y_{10} 16_F \Gamma 16_F 10_H + y_{126} 16_F \Gamma^5 16_F \overline{126}_H \quad (136)$$

Remarkably enough, this may be sufficient, without any higher dimensional operators; however, the situation is not completely clear.

There is a small number of parameters: $3 + 6 \times 2 = 15$ real Yukawa couplings, and 11 real parameters in the Higgs sector. In this sense the theory can be considered as the minimal supersymmetric GUT in general [71]. As usual, I am not counting the parameters associated with the SUSY breaking terms.

The nicest feature of this program (and the best justification for the use of large representations) is the following. Besides the $\langle(10, 1, 3)\rangle$ which gives masses to the ν_R 's, also the $\langle(15, 2, 2)\rangle$ in $\overline{126}_H$ gets a vev [69, 61]. Approximately

$$\langle(15, 2, 2)\rangle_{\overline{126}} \simeq \frac{M_{PS}}{M_{GUT}} \langle(1, 2, 2)\rangle \quad (137)$$

with $M_{PS} = \langle(15, 2, 2)\rangle$ being the scale of $SU(4)_c$ symmetry breaking. In SUSY, $M_{PS} \leq M_{GUT}$ and thus one can have correct mass relations for the charged fermions.

What is lost, though, is the $b - \tau$ unification, i.e. with $\langle(15, 2, 2)\rangle_{\overline{126}} \neq 0$, $m_b = m_\tau$ at M_{GUT} becomes an accident. However, in the case of type II see-saw, there is a profound connection between $b - \tau$ unification and a large atmospheric mixing angle. The fermionic mass matrices are obtained from (136)

$$M_u = v_{10}^u y_{10} + v_{126}^u y_{126} , \\ M_d = v_{10}^d y_{10} + v_{126}^d y_{126} , \\ M_e = v_{10}^d y_{10} - 3v_{126}^d y_{126} , \\ M_{\nu_D} = v_{10}^u y_{10} - 3v_{126}^u y_{126} , \quad (138)$$

$$M_{\nu_R} = y_{126} \langle(10, 1, 3)\rangle , \quad (139)$$

$$M_{\nu_L} = y_{126} \langle(\overline{10}, 3, 1)\rangle , \quad (140)$$

$$(141)$$

where $\langle(\overline{10}, 3, 1)\rangle \simeq M_W^2/M_{GUT}$ provides a direct (type II) see-saw mass for light neutrinos. The form in (138) is readily understandable, if you notice that $\langle(1, 2, 2)\rangle$ is a $SU(4)_c$ singlet with $m_q = m_\ell$, and $\langle(15, 2, 2)\rangle$ is a $SU(4)_c$ adjoint, with $m_\ell = -3m_q$. The vevs of the bidoublets are denoted by v^u and v^d as usual.

Now, suppose that type II dominates, or $M_\nu \propto y_{126} \propto M_e - M_d$, so that

$$M_\nu \propto M_e - M_d \quad (142)$$

Let us now look at the 2nd and 3rd generations first. In the basis of diagonal M_e , and for the small mixing ϵ_{de}

$$M_\nu \propto \begin{pmatrix} m_\mu - m_s & \epsilon_{de} \\ \epsilon_{de} & m_\tau - m_b \end{pmatrix} \quad (143)$$

obviously, large atmospheric mixing can only be obtained for $m_b \simeq m_\tau$ [58].

Exercise: *Prove that the above neutrino mass matrix requires $b - \tau$ unification in order to lead to a large mixing angle. Use the fact that the second generation masses are small in comparison with the third generation ones.*

Of course, there was no reason whatsoever to assume type II see-saw. Actually, we should reverse the argument: the experimental fact of $m_b \simeq m_\tau$ at M_{GUT} , and large θ_{atm} seem to favor the type type II see-saw. It can be shown, in the same approximation of 2-3 generations, that type I cannot dominate: it gives a small θ_{atm} [59]. This gives hope to disentangle the nature of the see-saw in this theory. As a check, it can be shown that the two types of see-saw are really inequivalent [59].

I wish to stress an important feature of this programme. Since 126 ($\overline{126}$) is invariant under matter parity, R parity remains exact at all energies and thus the lightest supersymmetric particle is stable and a natural candidate for the dark matter.

Mass scales In $SO(10)$ we have in principle more than one scale above M_W (and Λ_{SUSY}): the GUT scale, the Pati-Salam scale where $SU(4)_c$ is broken, the L-R scale where parity (charge conjugation) is broken, the scales of the breaking of $SU(2)_R$ and $U(1)_{B-L}$. Of course, these may be one and the same scale, as expected with low-energy supersymmetry. This solution is certainly there, since the gauge couplings of the MSSM unify successfully and encourage the single step breaking of $SO(10)$.

Is there any room for intermediate mass scales in SUSY $SO(10)$? It is certainly appealing to have an intermediate see-saw mass scale M_R , between

$10^{12} - 10^{15} GeV$ or so. In the non-renormalizable case, with 16_H and $\overline{16}_H$, this is precisely what happens: $M_R \simeq cM_{GUT}^2/M_{Pl} \simeq c(10^{13} - 10^{14})GeV$. In the renormalizable case, with 126_H and $\overline{126}_H$, one needs to perform a renormalization group study using unification constraints. While this is in principle possible, in practice it is hard due to the large number of fields. The stage has recently been set, for all the particle masses were computed [83, 84], and the preliminary studies show that the situation may be under control [85]. It is interesting that the existence of intermediate mass scales lowers the GUT scale [83, 86], allowing for a possibly observable $d = 6$ proton decay.

Notice that a complete study is basically impossible. In order to perform the running, you need to know particle masses precisely. Now, suppose you stick to the principle of minimal fine-tuning. As an example, you fine-tune the mass of the W and Z in the SM, then you know that the Higgs mass and the fermion masses are at the same scale

$$m_H = \frac{\sqrt{\lambda}}{g} m_W, \quad m_f = \frac{y_f}{g} m_W \quad (144)$$

where λ is a ϕ^4 coupling, and y_f an appropriate fermionic Yukawa coupling. Of course, you know the fermion masses in the SM model, and you know $m_H \simeq m_W$.

In an analogous manner, at some large scale m_G a group G is broken and there are usually a number of states that lie at m_G , with masses

$$m_i = \alpha_i m_G \quad (145)$$

where α_i is an approximate dimensionless coupling. Most renormalization group studies typically argue that $\alpha_i \simeq O(1)$ is natural, and rely on that heavily. In the SM, you could then take $m_H \simeq m_W$, $m_f \simeq m_W$; while reasonable for the Higgs, it is nonsense for the fermions (except for the top quark).

In supersymmetry *all* the couplings are of Yukawa type, i.e. self-renormalizable, and thus taking $\alpha_i \simeq O(1)$ may be as wrong as taking all $y_f \simeq O(1)$. While a possibly reasonable approach when trying to get a qualitative idea of a theory, it is clearly unacceptable when a high-precision study of M_{GUT} is called for.

Proton decay As you know, $d = 6$ proton decay gives $\tau_p(d = 6) \propto M_{GUT}^4$, while ($d = 5$) gives $\tau_p(d = 5) \propto M_{GUT}^2$. In view of the discussion above, the high-precision determination of τ_p appears almost impossible in $SO(10)$ (and even in $SU(5)$).

You may wonder if our renormalizable theory makes sense at all. After all, we are ignoring the higher dimensional operators of order $M_{GUT}/M_{Pl} \simeq 10^{-2} - 10^{-3}$. If they are present with the coefficients of order one, we can forget almost everything we said about the predictions, especially in the Yukawa sector. However, we actually know that the presence of $1/M_{Pl}$ operators is not automatic (at least not with the coefficients of order 1). Operators of the type (in symbolic notation)

$$O_5^p = \frac{c}{M_{Pl}} 16_F^4 \quad (146)$$

are allowed by $SO(10)$ and they give

$$O_5^p = \frac{c}{M_{Pl}} [(QQQL) + (Q^c Q^c Q^c L^c)] \quad (147)$$

These are the well-known $d = 5$ proton decay operators, and for $c \simeq O(1)$ they give $\tau_p \simeq 10^{23} yr$. Agreement with experiment requires

$$c \leq 10^{-6} \quad (148)$$

Exercise: *Hard. Prove the above result. Use the fact that the supersymmetric operator of the type $QQQL$ corresponds to an effective interaction $QL\tilde{Q}\tilde{Q}$ and then use the interactions with gauginos to transform $\tilde{Q}\tilde{Q}$ into QQ in order to create a proton decay operator $QQQL$. It happens at the one loop level.*

Could this be a signal that $1/M_{Pl}$ operators are small in general? Alternatively, you need to understand why just this one is to be so small. It is appealing to assume that this may be generic; if so, neglecting $1/M_{Pl}$ contributions in the study of fermion masses and mixings is fully justified.

7 Majorana Neutrinos: lepton number violation and the origin of neutrino mass

Majorana neutrino mass implies $\Delta L = 2$ processes:

1. neutrino-less double β decay
2. same sign dilepton par production at colliders [27]

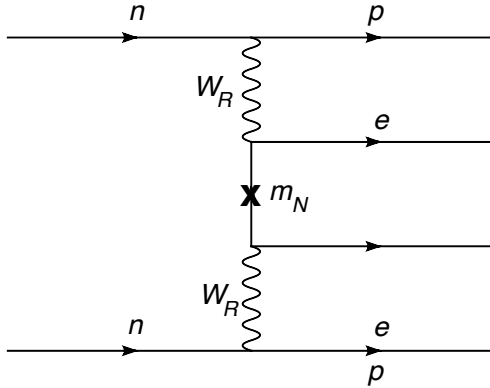

Figure 4: Neutrinoless double β decay through W_R and N

7.1 Neutrino-less double β decay

This is the usual text-book example of $\Delta L = 2$ and is often considered a probe of Majorana m_ν . However, the Majorana case needs a completion of the SM and $\beta\beta^0$ depends in general on the completion. A simple and clear example is provided by $L-R$ symmetric theories with low M_R scale in which case there are new contributions to $\beta\beta^0$. The dominant one is due to the W_R exchange and right-handed neutrinos N

It gives

$$(\beta\beta^0)_{RR} \propto \frac{1}{M_{W_R}^4} \left(\frac{1}{M_N} \right) ee \quad (149)$$

to be compared with the usual W_L contribution

$$(\beta\beta^0)_{LL} \propto \frac{1}{M_{W_L}^4} \frac{(m_\nu)_{ee}}{p^2} \quad (150)$$

where we assume $g_L \simeq g_R$ and p is the momentum exchange $p \simeq 100$ MeV.

We have

$$\frac{(\beta\beta^0)_{RR}}{(\beta\beta^0)_{LL}} \simeq \left(\frac{M_{W_L}}{M_{W_R}} \right)^4 \frac{p^2}{(m_\nu)_{ee}} \left(\frac{1}{M_N} \right) ee \quad (151)$$

For M_R in the few TeV region and $M_N \ll \text{TeV}$, the (RR) contribution tends to dominate over the (LL) one, and clearly right-handed neutrinos should not be too light.

Since $m_\nu \rightarrow 0$ when $y_D \rightarrow 0$, you can imagine a situation when neutrino mass is arbitrarily small, but $(\beta\beta^0)_{RR} \neq 0$ due to the N exchange.

Strictly speaking, $\beta\beta^0$ is not a measure of light neutrino masses and it will be hard to disentangle the origin of the see-saw through this process. In particular, we would need to know whether it is due to exchange of ν 's or

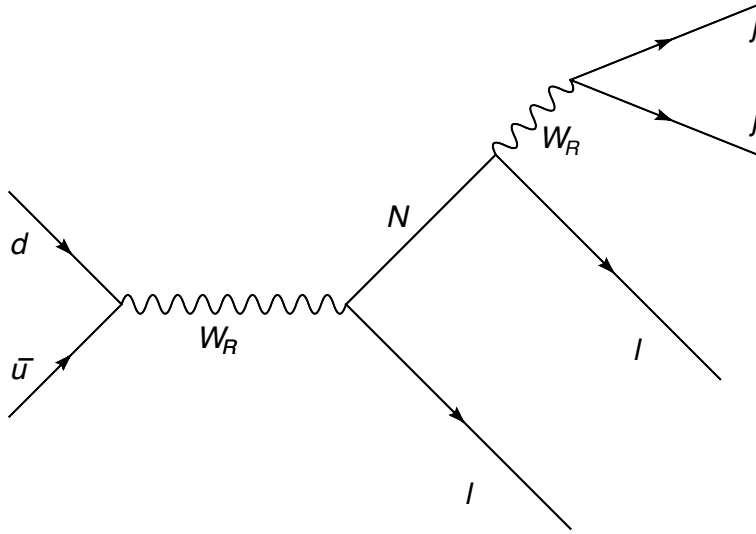

Figure 5: Production of lepton number violating same sign dileptons at colliders through W_R and N

heavy particles needed to complete the SM in order to have $m_\nu \neq 0$ (such as N_R).

It is thus crucial to have a direct measure of lepton number violation which can probe the source of neutrino Majorana mass. This is provided by the same sign dilepton production at colliders as we discuss below.

7.2 Lepton number violation at colliders

We have just seen that $\beta\beta^0$ is obscured by various contributions which are not easy to disentangle. We need some direct tests of the origin of $\Delta L = 2$, i.e. these-saw mechanism. This comes about from possible direct production of the right-handed neutrinos through a W_R production. The crucial point here is the Majorana nature of N : once produced it decays equally often into leptons and antileptons. This led us [27] to suggest a direct production of the same sign dileptons at colliders as a manifestation of $\Delta L = 2$. The most promising channel is $\ell\ell+2$ jets as seen from Fig.5.

One can also imagine a production of N through its couplings to W_L (proportional to y_D), but this is a long shot. It would require large y_D and large cancellations among the in order to have small m_ν . This could be achieved in principle by fine-tuning, but is not the see-saw mechanism.

The crucial characteristics

1. no missing energy which helps to fight the background

2. by measuring energies and momenta of the final states one can reconstruct both the mass of W_R and of the right-handed neutrino
3. the process can be amplified by the W_R resonance

The main background comes from $b\bar{b}+$ jets, but can be fought against with the usual cuts of large p_t for leptons and jets. Also important is $t\bar{t}+$ jets, which is less present but more resistant to large p_T cuts. Careful and complete studies were performed with encouraging results: one can easily discover W_R at the LHC up to $M_{W_R} \simeq 3.4$ TeV and $m_N \simeq 100$ GeV -TeV [72]. There have been recent claims of $M_R \gtrsim 4$ TeV [73] (or even $M_R \gtrsim 10$ TeV [74]) in the minimal theory, but these limits depend on the definition of $L - R$ symmetry and its manifestness. Namely, this limit stems from CP violation which depends on the definition of $L - R$ symmetry.

Recall that $L - R$ symmetry can be P as in the original works or C as it happens in $SO(10)$. The authors of [73, 74] use P, but it can be shown that in the case of C, the freedom in CP phases leaves only the CP conserving limit $M_R \gtrsim 2.4$ TeV [73]. This allows for both W_R and the accompanying neutral gauge boson Z_R to be seen at LHC.

In the L-R symmetric theories one also predicts type II see-saw as discussed before. Type II can also exist by itself in which case it can lead to rather interesting signatures at the colliders if the Δ triplets are light enough. In particular, it can lead to the production of doubly charged scalars that decay into same sign di-lepton pairs [75] as in Fig.6.

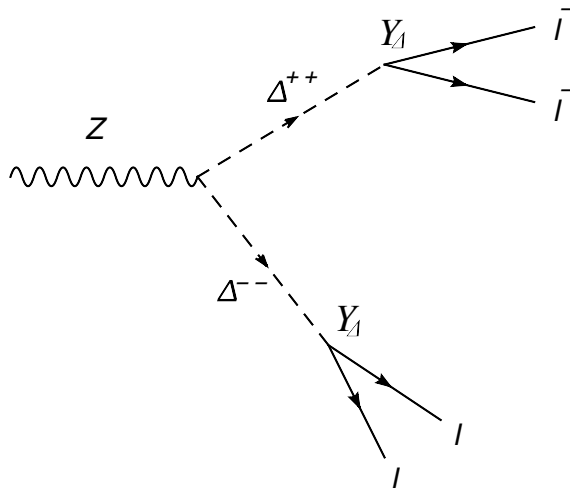

Figure 6: Production of a pair of double charged Higgs scalars and subsequent decay into pairs of same sign dileptons

Notice that Δ^{++} and Δ^{--} decay through the Yukawas y_Δ , these decays thus probe the neutrino mass matrix [76]

$$M_\nu = y_\Delta \langle \Delta \rangle \quad (152)$$

One can derive the sum rules for the flavor structure of Fig.6. Of course, this is valid only when these decays dominate over the decays with W bosons through $\langle \Delta \rangle$.

The relative strength of $\Delta^{--} \rightarrow \ell\ell$ and $\Delta^{--} \rightarrow W^-W^-$ depends on y_Δ . From

$$\Gamma(\Delta^{--} \rightarrow \ell\ell) \simeq \frac{y_\Delta^2}{8\pi} M_\Delta \quad (153)$$

and

$$\Gamma(\Delta^{--} \rightarrow W^-W^-) \simeq \frac{g^2 \langle \Delta \rangle^2}{8\pi M_\Delta} \quad (154)$$

for $M_\Delta \gg M_W$ one gets

$$B(\Delta^{--} \rightarrow \ell\ell) \equiv \frac{\Gamma(\Delta^{--} \rightarrow \ell\ell)}{\Gamma(\Delta^{--} \rightarrow W^-W^-)} \simeq \frac{y_\Delta^2 M_\Delta^2}{g^2 \langle \Delta \rangle^2} \quad (155)$$

Thus $B(\Delta^{--} \rightarrow \ell\ell) \geq 1$ requires that the vev of Δ be as small and y_Δ large. Ideally, observing both decays would establish $SU(2)$ gauge triplet property of Δ and could measure the form of the neutrino mass matrix. The widely separated di-lepton pairs in the case of $B(\Delta^{--} \rightarrow \ell\ell) \geq 1$ provide a clean manifestation of the Type II see-saw mechanism and allow for the discovery of Δ^{++} with $M_\Delta \leq 800\text{GeV}$. This can be boosted even more if one manages to produce the heavy neutral gauge boson Z_R , for then one can sit at its resonance. In any case, even the seesaw is not of type II, the possibility of the discovery of the doubly charged Δ scalars remains feasible. It is important to perform a complete analysis of the $L-R$ symmetric model at LHC. For an earlier attempt see e.g. [77]. In short, both type I and II could lead to exciting $\Delta L = 2$ signatures at LHC, if W_R and N and/or Δ are light enough. But, as will be discussed later, in predictive grand unified theories such as minimal $SO(10)$, they are expected to be rather heavy, out of reach for LHC.

One can ask the same question in the case of Type III see-saw. As we said, one would need at least the fermionic triplets in order to have at least two massive neutrinos, one could have a hybrid situation of of Type I and Type III see-saw, with a heavy fermionic singlet (N) and triplet (T). This case is particularly interesting, since it emerges naturally in the $SU(5)$ grand unified theory. Again, the process of interest for LHC is a production of same sign dileptons (but now with 4 jets) as in Fig.7

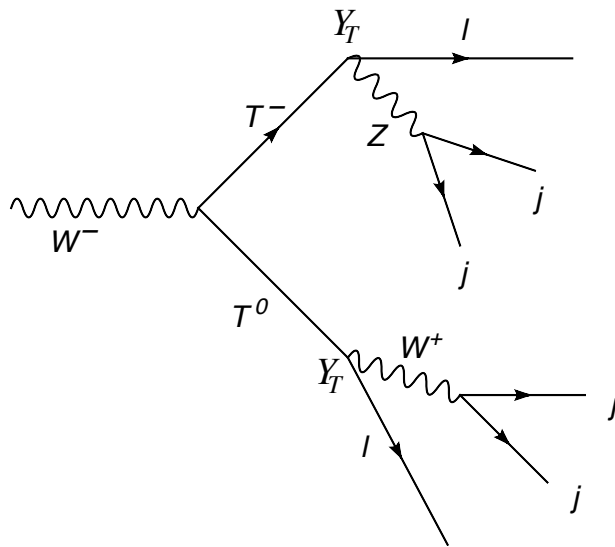

Figure 7: The same sign dilepton signature of type III seesaw through the production of the charged and neutral components of a fermion triplet T_F

The main point here is that in the minimal $SU(5)$ theory augmented by an adjoint fermionic representation 24_F the fermion triplet T_F is predicted to lie below TeV , and thus the above process is a realistic possibility at colliders such as LHC.

8 Summary and outlook

The smallness of neutrino mass is an intriguing fact that gives hope of being a window into a new physics beyond the standard model. This crucially depends on the nature of neutrino mass, i.e. whether it is Dirac or Majorana. In the former case, the standard model is a complete theory and although the smallness of neutrino mass is attributed to the smallness of Dirac Yukawa couplings. True, it is not explained, but strictly speaking there may be no new physics, the same way that there may be no new physics behind the smallness of electron mass. In the limit of small Yukawas one has more symmetry, and thus small Yukawas are technically natural, protected from high energy physics. The Dirac case thus gives no clue where to look for a new physics. Of course, one can always search for horizontal symmetries as the explanation of small Yukawas, but here there is a danger of only changing the language.

The Majorana case on the other hand provides a clear window into new physics for the MSM with Majorana neutrino mass is not a complete theory.

At the same time, this case implies a violation of lepton number through a neutrino-less double beta decay as is well known and the possible production of the same sign di-leptons, less known but becoming a new hot field in itself. The completion of the MSM that produces small neutrino Majorana mass results in the celebrated seesaw mechanism which comes in three different varieties. In order to be predictive, though, the seesaw mechanism needs a theory behind, for otherwise it is simply a linguistic variation on the effective $d=5$ operator that we saw necessarily describes neutrino mass after the new states are integrated out. One important theory which leads to both type I and II seesaw is based on L-R symmetry, and has been a principle source of neutrino mass and seesaw. If the scale of L-R symmetry breaking were to be in the TeV region, one would have a possibility of seeing both the parity restoration and the origin of the neutrino mass through the production of a right handed charged boson and right-handed neutrinos. Similarly, one could in principle produce the scalar triplet responsible for the type II seesaw. The scale of L-R breaking can be predicted only in grand unification and in simple, predictive models it is quite large, far above the TeV scale of colliders. Still, one may be able to connect the values of neutrino masses and mixings with the predictions for the branching ratios of proton decay and thus have a check on the theory, albeit indirect.

On the other hand, the type III seesaw finds its natural realization in $SU(5)$ grand unified theory, when the minimal model of Georgi and Glashow is augmented by an adjoint fermion representation. This allows for the unification of gauge couplings and provides a hybrid type I and III seesaw. One predicts one massless neutrino and more important a light weak triplet fermion, with a mass below TeV. The decays of the triplet probe neutrino masses and mixings through the lepton number violating production of same sign dileptons accompanied by four jets. The hope of finding the origin of neutrino mass becomes feasible at colliders such as LHC.

In summary, I tried to argue in these lectures in favor of Majorana masses of neutrinos, and the possibility of seeing its origin through lepton number violation or the connection with proton decays. The lepton number violation will be searched for in the new generation of neutrino-less double beta decay and at LHC. Hopefully, a serious effort will be put in the next generation of proton decay experiments; they could be simultaneously a probe of baryon number violation in nature and an origin of neutrino masses and mixings.

A Dirac and Majorana masses

The irreducible spin 1/2 representations of the Lorentz group are the two-component left- and right-handed chiral fermion Weyl fields u_L and u_R , which transform under the Lorentz group as

$$u_{L,R} \rightarrow \Lambda_{L,R} u_{L,R} \quad (156)$$

with

$$\begin{aligned} \Lambda_L &\equiv e^{i\vec{\sigma}/2(\vec{\theta}+i\vec{\phi})} \\ \Lambda_R &\equiv e^{i\vec{\sigma}/2(\vec{\theta}-i\vec{\phi})} \end{aligned} \quad (157)$$

The three Euler angles $\vec{\theta}$ stand for rotations, and $\vec{\phi}$ denotes the boosts. The spinors ψ_L and ψ_R transform the same under the rotations, but in an opposite manner under the boosts.

It is straightforward to show that the following bilinear combinations are Lorentz invariant

$$\begin{aligned} (M) \quad & u_L^T i\sigma_2 u_L \quad \text{and} \quad u_R^T i\sigma_2 u_R \quad (\text{Majorana type}) \\ (D) \quad & u_L^\dagger u_R \quad \text{and} \quad u_R^\dagger u_L \quad (\text{Dirac type}) \end{aligned} \quad (158)$$

Historically, the Dirac type came first, but in a sense the Majorana invariant is even more fundamental for it needs only one species of fermions.

To bridge the gap with Dirac four-component fermions, we need the Dirac algebra

$$\{\gamma^\mu, \gamma^\nu\} = 2g^{\mu\nu} \quad g^{\mu\nu} = \text{diag}(1, -1, -1, -1) \quad (159)$$

with

$$\gamma^i = \begin{pmatrix} 0 & \sigma^i \\ -\sigma^i & 0 \end{pmatrix}, \quad \gamma^0 = \begin{pmatrix} 0 & 1_2 \\ 1_2 & 0 \end{pmatrix} \quad (160)$$

$$\gamma_5 = i\gamma^1\gamma^2\gamma^3\gamma^0 = \begin{pmatrix} 1_2 & 0 \\ 0 & -1_2 \end{pmatrix} \quad (161)$$

where

$$\Sigma_{\mu\nu} = \frac{1}{4i}[\gamma_\mu, \gamma_\nu] \quad (162)$$

generate Lorentz algebra and where γ_5 has the properties

$$\gamma_5^2 = 1, \quad [\gamma_5, \Sigma_{\mu\nu}] = 0, \quad \{\gamma_5, \gamma_\mu\} = 0. \quad (163)$$

One can define L and R projectors

$$P_{L,R} \equiv \frac{1 \pm \gamma_5}{2} \quad (164)$$

A four component spinor ψ transforms under Lorentz transformations

$$\psi \rightarrow \Lambda \psi \quad (165)$$

where

$$\Lambda \equiv e^{i\Sigma_{\mu\nu}\theta^{\mu\nu}} \quad (166)$$

One can write

$$\psi \equiv \psi_L + \psi_R \quad (167)$$

with

$$\psi_L = P_L \psi \quad \psi_R = P_R \psi \quad (168)$$

The $\Lambda_{L,R}$ introduced in (????????) are simply

$$\Lambda_{L,R} = P_{L,R} \Lambda \quad (169)$$

The Dirac charge conjugation, defined through

$$C^T \gamma^\mu C = -\gamma_\mu^T, \quad C^T = -C \quad (170)$$

is with my conventions

$$C = i\gamma_2\gamma_0 \quad (171)$$

In other words, the Majorana mass term can be written as

$$(M) m_M(\psi_L^T C \psi_L + h.c.) \quad (172)$$

and the Dirac one as

$$(D) m_D(\bar{\psi}_L \psi_R + \bar{\psi}_R \psi_L) \equiv m_D \bar{\psi}_D \psi_D \quad \psi_D \equiv \psi_L + \psi_R \quad (173)$$

This in turn gives

$$\psi_D = \begin{pmatrix} u_L \\ u_R \end{pmatrix} \quad (174)$$

since

$$\psi_L = \begin{pmatrix} u_L \\ 0 \end{pmatrix} \quad \text{and} \quad \psi_R = \begin{pmatrix} 0 \\ u_R \end{pmatrix} \quad (175)$$

It is convenient to work with left-handed antiparticles instead of right-handed particles

$$(\psi^C)_L \equiv C \bar{\psi}_R^T \quad (176)$$

in which case one can write a mass matrix for ψ_L and $(\psi^C)_L$ in the Majorana notation $(\psi_1^T C \psi_2)$

$$\begin{pmatrix} m_L & m_D \\ m_D & m_R \end{pmatrix} \quad (177)$$

where m_L and m_R are the Majorana mass terms of ψ_L and ψ_R respectively. The case of a pure Dirac fermion simply means $m_L = m_R = 0$.

If neutrino mass is of the Majorana type on the other hand, it will imply a violation of the lepton number and a new rich physics associated with it.

B Majorana spinors: Feynman rules

Take a two-component spinor with left-handed chirality ψ_L with the following Lagrangian

$$\mathcal{L}_M = i\bar{\psi}_L\gamma^\mu\partial_\mu\psi_L - \left(\frac{m_M}{2}\psi_L^T C\psi_L + h.c.\right) \quad (178)$$

where the subscript M indicates the Majorana nature of the mass term. In order to bridge the gap with the familiar 4-component Dirac case, introduce by analogy

$$\psi_M \equiv \psi_L + C\bar{\psi}_L^T \quad (179)$$

or

$$\psi_M = \begin{pmatrix} u_L \\ i\sigma_2 u_L^* \end{pmatrix} \quad (180)$$

In other words, Majorana spinor is real and can denote only a neutral particle such as neutrino. This is manifest in the original Majorana representation [15].

From

$$\bar{\psi}_M\gamma^\mu\partial_\mu\psi_M = 2\bar{\psi}_L\gamma^\mu\partial_\mu\psi_L \quad (181)$$

and

$$\bar{\psi}_M\psi_M = \psi_L^T C\psi_L + h.c. \quad (182)$$

we get

$$\mathcal{L}_M = \frac{1}{2} [i\bar{\psi}_M\gamma^\mu\partial_\mu - m_M\bar{\psi}_M\psi_M] \quad (183)$$

Two important facts emerge

1. m_M is the (Majorana) mass of ψ_M
2. one can use the usual Dirac case Feynman rules

C $SU(N)$ group theory

On a fundamental N-dimensional complex representation Φ , the $SU(N)$ group acts as

$$\Phi \rightarrow U\Phi, \quad U^\dagger U = 1, \quad \det(U) = 1 \quad (184)$$

and U can be written as

$$U = e^{-i\theta_a T_a} \quad a = 1..N^2 - 1 \quad (185)$$

where the group generators T_a satisfy

$$T_a = T_a^\dagger, \quad Tr(T_a) = 0, \quad [T_a, T_b] = if_{abc}T_c \quad (186)$$

where f_{abc} are the group structure constants. There is also a complex conjugate representation

$$\Phi^* \rightarrow U^* \Phi^* \quad (187)$$

and an $(N^2 - 1)$ -dimensional adjoint representation

$$A \rightarrow UAU^\dagger = A - i\theta^a [T_a, A] + \dots \quad (188)$$

In other words, the generators act on A as commutators. One can write $A = A_a T_a$, so that A_a transforms under a small group rotation as

$$A_a \rightarrow A_a + f_{abc} \theta_b A_c \quad (189)$$

Examples of fields transforming as the adjoint representation are the gauge bosons A of $SU(N)$ and the heavy scalars Σ employed to break the grand unified symmetry. The reason for the latter is the fact that under a unitary transformation $\langle \Sigma \rangle \rightarrow U \langle \Sigma \rangle U^\dagger$, one can have $\langle \Sigma \rangle$ diagonal, which in turn implies

$$[\langle \Sigma \rangle, T_a \in Cartan] = 0 \quad (190)$$

The adjoint Higgs preserves the rank of the group after the symmetry breaking. This is specially important in $SU(5)$ since it has the same rank (=4) as the SM gauge group.

All other representations are built out of the fundamental Φ (and/or Φ^*) by symmetrizing and antisymmetrizing (and subtracting the trace when necessary). For example

$$\Phi_i \Phi_j = \Phi_{[i,j]} + \Phi_{\{i,j\}} \quad (191)$$

$$\frac{N(N-1)}{2} \quad \frac{N(N+1)}{2} \quad (192)$$

This means that all the charges get summed up

$$Q(\Phi_i \Phi_j) = Q(\Phi_i) + Q(\Phi_j) \quad (193)$$

D $SO(2N)$ group theory

$SO(2N)$ is the group of real orthogonal transformations, $O^T O = O O^T = 1$, with $\det(O) = 1$. It can be generated by $N(N-1)/2$ Hermitean antisymmetric matrices

$$O = e^{-i\theta_{ij} L_{ij}} \quad (194)$$

with

$$(L_{ij})_{kl} = -i(\delta_{ik}\delta_{jl} - \delta_{il}\delta_{jk}) \quad (195)$$

so that one has the following commutation relations

$$[L_{ij}, L_{kl}] = i(\delta_{ik}L_{jl} - \delta_{jl}L_{ik}) \quad (196)$$

The N -dimensional Cartan subalgebra is spanned by

$$Cartan = \{L_{12}, L_{34}, \dots, L_{2N-1, 2N}\} \quad (197)$$

whose eigenvalues are ± 1 . The fundamental (vector) representation transforms as

$$\Phi_i \rightarrow O_{ij}\Phi_j \quad (198)$$

and is generated by L_{ij} in 195. One can construct the general N -index irreducible representation by antisymmetrizing or symmetrizing (and subtracting traces) N times the vector representation. Rather interesting are the $[N]$ -index antisymmetric ones, for one can complexify them by introducing

$$\Phi_{[a_1 \dots a_N]}^\pm = \Phi_{[a_1 \dots a_N]} \pm \frac{i^N}{N!} \epsilon_{a_1 \dots a_N b_1 \dots b_N} \Phi_{b_1 \dots b_N} \quad (199)$$

We illustrate this on a simple example below in $SO(2)$ where this amounts to just complexifying a fundamental representation. It turns out that such 5 index antisymmetric 126 dimensional representation of $SO(10)$ plays a profound role in a physics of neutrino mass; this is discussed in the section 6.

D.0.1 $SO(2N)$: spinors

By analogy with the Dirac algebra in Minkowski space, an Euclidean version is based on the Clifford algebra of the Γ_i matrices ($i = 1 \dots 2N$)

$$\{\Gamma_i, \Gamma_j\} = 2\delta_{ij} \quad (200)$$

out of which one can construct $N(N-1)/2$ generators

$$\Sigma_{ij} = \frac{1}{4i} [\Gamma_i, \Gamma_j] \quad (201)$$

which satisfy the usual commutation relations of the $SO(2N)$ generators in 196. It is easy to see that the Cartan subalgebra consists of N generators

$$Cartan = \{\Sigma_{12}, \dots, \Sigma_{2N-1, 2N}\} \quad (202)$$

whose eigenvalues are $\pm 1/2$.

The appropriate 2^N -dimensional complex representation Ψ is called a spinor of $SO(2N)$. Adding a spinor changes of course a group, just as $SO(3)$ becomes $SU(2)$. One often calls $SO(10)$ with spinors $Spin(2N)$. The spinors transforms in the following manner

$$\Psi \rightarrow e^{-i\theta_{ij}\Sigma_{ij}}\Psi \quad (203)$$

Again, by analogy with Dirac γ_5 matrix one can introduce

$$\Gamma_{\text{FIVE}} = (-1)^N \Gamma_1 \dots \Gamma_{2N} \quad (204)$$

with the properties

$$\Gamma_{\text{FIVE}}^2 = 1, \quad [\Gamma_{\text{FIVE}}, \Sigma_{ij}] = 0, \quad \{\Gamma_{\text{FIVE}}, \Gamma_i\} = 0 \quad (205)$$

By using the projectors

$$\Gamma_{+(-)} \equiv \frac{1 \pm \Gamma_{\text{FIVE}}}{2} \quad (206)$$

one can construct the irreducible 2^{N-1} dimensional spinors

$$\Psi_{\pm} \equiv \Gamma_{+(-)}\Psi \quad (207)$$

by analogy with Weyl spinors of the Lorentz group.

One can also introduce the analogue of the usual charge conjugation by demanding that

$$\Psi^T B \Psi = \text{invariant} \Leftrightarrow \Psi^c \equiv B \Psi^* \quad (208)$$

which amounts to

$$\Sigma^T B + B \Sigma = 0 \quad (209)$$

There are two possible solutions for B

$$B_{(1)} = \Gamma_1 \dots \Gamma_{2N-1}, \quad ; B_{(2)} = \Gamma_2 \dots \Gamma_{2N} \quad (210)$$

D.0.2 The ket notation for spinors

From

$$\Gamma_{\text{FIVE}} = 2\Sigma_{12} \dots 2\Sigma_{2N+1, 2N} \quad (211)$$

one can write

$$\Gamma_{\text{FIVE}} = \epsilon_1 \epsilon_2 \dots \epsilon_N \quad (212)$$

where ϵ_i are ± 1 , the eigenvalues of $\Sigma_{2i-1,2i}$. Then one can denote the Ψ_+ spinors as a ket

$$\Psi_+ \equiv |\epsilon_1 \dots \epsilon_N\rangle \quad (213)$$

For example, take the spinors Ψ_+ of $SO(10)$

$$\Psi_+ \equiv |\epsilon_1 \dots \epsilon_5\rangle; \quad \epsilon_1 \dots \epsilon_5 = +1 \quad (214)$$

The 16-component Ψ_+ can be decomposed as

$$\Psi_+ = \begin{cases} 1 \text{ field} & |++++\rangle \\ 10 \text{ fields} & |+++--\rangle, |++-+-\rangle, |+-+--\rangle \\ & |+-+--\rangle, |+-+--\rangle, |+-+--\rangle \\ & |-+++--\rangle, |-+++--\rangle, |-+++--\rangle, |--++++\rangle \\ 5 \text{ fields} & |+-+--\rangle, |-+---\rangle \\ & |--+--\rangle, |--+--\rangle, |--+--\rangle \end{cases} \quad (215)$$

We will see that this can be interpreted as a decomposition under $SU(5)$

$$16 = 10 + \bar{5} + 1 \quad (216)$$

In other words, a family of fermions augmented by a right-handed neutrino makes an irreducible spinorial representation of $SO(10)$. The unification of matter, on top of gauge interactions, points strongly towards $SO(10)$. However, in order to appreciate this fact and have fun with $SO(10)$, we first go through some pedagogical exposition of smaller groups.

D.0.3 $SO(2)$: a prototype for $SO(4n+2)$

We choose

$$\Gamma_1 = \sigma_1, \quad \Gamma_2 = \sigma_2 \quad (217)$$

so that

$$\Gamma_{\text{FIVE}} = \sigma_3, \quad \Sigma_{12} = \frac{\sigma_3}{2} \quad (218)$$

which illustrates clearly $[\Gamma_{\text{FIVE}}, \Sigma_{i,j}] = 0$. The irreducible 1-component spinors transform as

$$\Psi_+ \rightarrow e^{-i\theta/2} \Psi_+, \quad \Psi_- \rightarrow e^{+i\theta/2} \Psi_- \quad (219)$$

since

$$\Psi \equiv \begin{pmatrix} \Psi_+ \\ \Psi_- \end{pmatrix} \rightarrow e^{-i\theta\sigma_3/2} \begin{pmatrix} \Psi_+ \\ \Psi_- \end{pmatrix} \quad (220)$$

On the other hand, the two-component vectors transform as

$$\begin{pmatrix} \phi_1 \\ \phi_2 \end{pmatrix} \rightarrow \begin{pmatrix} \cos \theta & \sin \theta \\ -\sin \theta & \cos \theta \end{pmatrix} \begin{pmatrix} \phi_1 \\ \phi_2 \end{pmatrix} \quad (221)$$

or

$$\phi_1 \pm i\phi_2 \rightarrow e^{\pm i\theta}(\phi_1 \pm i\phi_2) \quad (222)$$

Eqs. 219 and 222 simply account for the fact $SO(2) \simeq U(1)$.

The internal ‘‘charge’’ conjugation B can be chosen as $B_1 = \sigma_1$, so that

$$\Psi^T B \Psi = \Psi_+ \Psi_- \quad (223)$$

However, only Ψ_+ (or Ψ_-) is an irreducible spinor, therefore there is no mass term for an irreducible spinor of $SO(2)$. In other words, the spinors Ψ_+ (Ψ_-) are chiral and can represent physical particles such as the fermions of the SM. This is true in any $SO(4n+2)$ theory. In particular, in $SO(10)$, which means that it offers hope of being realistic.

Dual representation From

$$\epsilon_{ij} \det O = O_{ik} O_{jl} \epsilon_{kl} \quad (224)$$

is easy to see that ϕ_i and $\epsilon_{ij}\phi_j$ transform in the same way. We can introduce the self (anti-self) dual representation

$$\Phi_i(\pm) = \frac{1}{\sqrt{2}}(\phi_i \pm i\epsilon_{ij}\phi_j) \quad (225)$$

which is nothing else but the complex representation of $U(1)$ 222. This should make clear the generic concept of self dual representations in $SO(2N)$ discussed before.

Yukawa couplings We have seen that there is no direct mass term. There are Yukawa couplings, though, of the type

$$\begin{aligned} \mathcal{L}_Y &= \Psi^T B \sigma_i \Psi \phi_i \\ &= \Psi_+ \Psi_+(\phi_1 - i\phi_2) + \Psi_- \Psi_-(\phi_1 + i\phi_2) \end{aligned} \quad (226)$$

as dictated by $U(1)$ charges.

D.0.4 $SO(4)$

One knows that $SO(4)$ is isomorphic to $SU(2) \times SU(2)$, and it plays an important role in providing a left-right symmetric subgroup of $SO(10)$. It is an Euclidean analog of the Lorentz group and the Clifford algebra can be generated by

$$\begin{aligned}\Gamma_1 &= \begin{pmatrix} 0 & \sigma_1 \\ \sigma_1 & 0 \end{pmatrix} & \Gamma_2 &= \begin{pmatrix} 0 & \sigma_2 \\ \sigma_2 & 0 \end{pmatrix} \\ \Gamma_3 &= \begin{pmatrix} 0 & \sigma_3 \\ \sigma_3 & 0 \end{pmatrix} & \Gamma_4 &= \begin{pmatrix} 0 & -i \\ i & 0 \end{pmatrix}\end{aligned}\quad (227)$$

so that

$$\Gamma_{\text{FIVE}} = \begin{pmatrix} 1 & 0 \\ 0 & -1 \end{pmatrix}\quad (228)$$

and ‘‘charge’’ conjugation can be taken as

$$B_{(1)} = \Gamma_1 \Gamma_3 = \begin{pmatrix} -i\sigma_2 & 0 \\ 0 & -i\sigma_2 \end{pmatrix}\quad (229)$$

or

$$B_{(2)} = \Gamma_2 \Gamma_4 = \begin{pmatrix} i\sigma_2 & 0 \\ 0 & -i\sigma_2 \end{pmatrix}\quad (230)$$

The mass term

$$\Psi^T B \Psi \propto \Psi_+^T i\sigma_2 \Psi_+ + \dots\quad (231)$$

where

$$\Psi_{\pm} = \frac{1 \pm \Gamma_5}{2} \Psi_{\pm}\quad (232)$$

In other words, the mass term for Ψ_+ (or Ψ_-) is invariant, which means that we can have no chiral fermions in $SO(4)$. This is true for all $SO(4n)$ groups.

In the ket notation

$$\Psi_+ = |\epsilon_1 \epsilon_2\rangle; \quad \epsilon_1 \epsilon_2 = 1; \quad \epsilon_{1,2} = \pm 1\quad (233)$$

or

$$\Psi_+ = \begin{pmatrix} |++\rangle \\ |--\rangle \end{pmatrix}\quad (234)$$

Introduce the neutral generator of $SU(2)_L$ and $SU(2)_R$

$$T_{3L} \equiv \frac{1}{2}(\Sigma_{12} + \Sigma_{34}), \quad T_{3R} \equiv \frac{1}{2}(\Sigma_{12} - \Sigma_{34})\quad (235)$$

and you see that Ψ_+ is an $SU(2)_L$ doublet, $SU(2)_R$ singlet field, an analog of left-handed Weyl spinors of the Lorentz group. Similarly, Ψ_- is an $SU(2)_L$ singlet, $SU(2)_R$ doublet field.

D.0.5 $SO(6)$

$SO(6) \sim SU(4)_C$ is the Pati-Salam group of quark-lepton symmetry, with leptons as the fourth color. It deserves a brief description.

Start with a six-dimensional vector Φ_i ($i=1..6$). It is easy to see that the components $(\phi_1 \pm \phi_2)$, $(\phi_3 \pm \phi_4)$, $(\phi_5 \pm \phi_6)$ transform as 3 and 3^* of its subgroup $SU(3)$ which we identify with the color.

The neutral generators are identified as

$$\begin{aligned} T_{3C} &= \frac{1}{2}(\Sigma_{12} - \Sigma_{34}) \\ T_{8C} &= \frac{1}{2}(\Sigma_{12} + \Sigma_{34} - 2\Sigma_{56}) \end{aligned} \quad (236)$$

The additional neutral generator of $SU(4)$, identifiable as $B - L$, can be written as

$$B - L = -\frac{2}{3}(\Sigma_{12} + \Sigma_{34} + \Sigma_{56}) \quad (237)$$

Regarding spinors, the positive chirality can be written as

$$\Psi_+ = \begin{cases} \text{color singlet} & |+++ \rangle \\ \text{color triplet } (B - L) = 1/3 & |+-- \rangle, |-+- \rangle, |--+ \rangle \end{cases} \quad (238)$$

It says simply that the irreducible 4-component spinor of $SO(6)$ is a fundamental of $SU(4)$ with the decomposition under $SU(3)_C$ (with $B - L$)

$$\Psi_+ = 4 = 1_{-1} + 3_{1/3} \quad (239)$$

which is precisely a combination of a lepton and a colored quark. Similarly, $\Psi_i = 4^* = 1_{+1} + 3_{-1/3}$ stands for an antilepton and antiquark.

Exercise:

As a check, show that $4 \times 4 = 6 + 10$. Show that 6 of $SO(6)$ has the quantum number of the 6 (antisymmetric) of $SU(4)$.

Yukawa couplings in $SO(6)$ We know that the irreducible spinors of $SO(6)$ are fundamental representations of $SU(4)$ and $4 \times 4 = 6 + 10$. There are then two types of Yukawa couplings

$$\mathcal{L}_Y = y_6 \Psi^T B \Gamma_i \Psi \Phi_i + y_{10} \Psi^T B \Gamma_i \Gamma_j \Gamma_k \Psi \Phi_{[ijk]}^- \quad (240)$$

where it is a simple exercise to show that $\Phi_{[ijk]}^-$ is an anti-self-dual representation

$$\Phi_{ijk}^- = \Phi_{[ijk]}^- = \frac{i}{3!} \epsilon_{ijklmn} \Phi_{[lmn]} \quad (241)$$

and where $\Phi_{[ijk]}^-$ is the 3-index antisymmetric tensor of $SO(6)$.

Exercise: Construct the self-dual and anti-self-dual representation of $SO(6)$ out of the 3-index antisymmetric representation $\Phi_{[ijk]}$. Show that $20 = 10 + \overline{10}$. Then prove equation 240 and show that there are no other couplings

Exercise: Take the Pati-Salam group $SO(4) \times SO(6) \simeq SU(2)_L \times SU(2)_R \times SU(4)_c$. Show that the representations $(2, 1, 4)$ and $(1, 2, \overline{4})$ give a family of quarks and leptons augmented by a right-handed neutrino

Exercise: The chiral anomalies are proportional to $\Lambda_{ijk} = \text{Tr}(\{T_i, T_j\}T_k)$. Show that the $SO(2N)$ groups are anomaly free, except for the $SO(6)$. Comment on why $SO(6)$ must have an anomaly

References

- [1] R. N. Mohapatra and P. B. Pal, World Sci. Lect. Notes Phys. **60** (1998) 1 [World Sci. Lect. Notes Phys. **72** (2004) 1].
- [2] A. Strumia and F. Vissani, arXiv:hep-ph/0606054.
- [3] R. N. Mohapatra, "Unification and Supersymmetry. The Frontiers of Quark - Lepton Physics," *Berlin, Germany: Springer (1986) 309 P. Contemporary Physics*
- [4] G. G. Ross, "Grand Unified Theories," *Reading, Usa: Benjamin/cummings (1984) 497 P. (Frontiers In Physics, 60)*
- [5] J. S. Schwinger, Annals Phys. **2** (1957) 407.
- [6] H. Georgi and S. L. Glashow, Phys. Rev. Lett. **28**, 1494 (1972).
- [7] G. 't Hooft, Nucl. Phys. B **79**, 276 (1974).
- [8] A. M. Polyakov, JETP Lett. **20** (1974) 194 [Pisma Zh. Eksp. Teor. Fiz. **20** (1974) 430].

- [9] S. L. Glashow, Nucl. Phys. **22**, 579 (1961).
- [10] S. Weinberg, Phys. Rev. Lett. **19**, 1264 (1967).
- [11] A. Salam, *Originally printed in *Svartholm: Elementary Particle Theory, Proceedings Of The Nobel Symposium Held 1968 At Lerum, Sweden*, Stockholm 1968, 367-377*
- [12] H. Georgi and S. L. Glashow, Phys. Rev. Lett. **32**, 438 (1974).
- [13] P. A. M. Dirac, Phys. Rev. **74**, 817 (1948).
- [14] S. Weinberg, Phys. Rev. Lett. **43** (1979) 1566.
- [15] E. Majorana, Nuovo Cim. **14**, 171 (1937).
- [16] G. Racah, Nuovo Cim. **14**, 322 (1937)
- [17] W. H. Furry, Phys. Rev. **56**, 1184 (1939).
- [18] P. Minkowski, Phys. Lett. B **67** (1977) 421;
- [19] T. Yanagida, proceedings of the *Workshop on Unified Theories and Baryon Number in the Universe*, Tsukuba, 1979, eds. A. Sawada, A. Sugamoto; S. Glashow, in *Cargese 1979, Proceedings, Quarks and Leptons* (1979) ;
- [20] M. Gell-Mann, P. Ramond, R. Slansky, proceedings of the *Supergravity Stony Brook Workshop*, New York, 1979, eds. P. Van Nieuwenhuizen, D. Freeman
- [21] R. Mohapatra, G. Senjanović, Phys.Rev.Lett. **44** (1980) 912.
- [22] M. Magg and C. Wetterich, Phys. Lett. B **94** (1980) 61;
- [23] G. Lazarides, Q. Shafi and C. Wetterich, Nucl. Phys. B **181** (1981) 287;
- [24] R. N. Mohapatra and G. Senjanović, Phys. Rev. D **23** (1981) 165.
- [25] R. Foot, H. Lew, X. G. He and G. C. Joshi, Z. Phys. C **44** (1989) 441;
- [26] E. Ma, Phys. Rev. Lett. **81** (1998) 1171 [arXiv:hep-ph/9805219].
- [27] W. Y. Keung and G. Senjanović, Phys. Rev. Lett. **50** (1983) 1427.
- [28] J. C. Pati and A. Salam, Phys. Rev. D **10** (1974) 275.

- [29] R. N. Mohapatra and J. C. Pati, Phys. Rev. D **11** (1975) 2558.
- [30] G. Senjanović and R. N. Mohapatra, Phys. Rev. D **12** (1975) 1502.
- [31] G. Senjanović, Nucl. Phys. B **153** (1979) 334.
- [32] Y. Zhang, H. An, X. Ji and R. N. Mohapatra, Nucl. Phys. B **802**, 247 (2008) [arXiv:0712.4218 [hep-ph]].
- [33] F. Xu, H. An and X. Ji, arXiv:0910.2265 [hep-ph].
- [34] M. S. Chanowitz, J. R. Ellis and M. K. Gaillard, Nucl. Phys. B **128**, 506 (1977).
A. J. Buras, J. R. Ellis, M. K. Gaillard and D. V. Nanopoulos, Nucl. Phys. B **135** (1978) 66.
- [35] J. R. Ellis and M. K. Gaillard, Phys. Lett. B **88**, 315 (1979).
- [36] R. N. Mohapatra, Phys. Rev. Lett. **43**, 893 (1979).
- [37] F. Wilczek and A. Zee, Phys. Lett. B **88**, 311 (1979).
- [38] S. Dimopoulos, S. Raby, F. Wilczek, Phys. Rev. D **24** (1981) 1681.
- [39] L.E. Ibáñez, G.G. Ross, Phys. Lett. B **105** (1981) 439.
- [40] M.B. Einhorn, D.R. Jones, Nucl. Phys. B **196** (1982) 475.
- [41] W. Marciano, G. Senjanović, Phys.Rev.D **25** (1982) 3092.
- [42] H. Nishino *et al.* [Super-Kamiokande Collaboration], Phys. Rev. Lett. **102**, 141801 (2009) [arXiv:0903.0676 [hep-ex]].
- [43] N. Sakai and T. Yanagida, Nucl. Phys. B **197**, 533 (1982).
S. Weinberg, Phys. Rev. D **26** (1982) 287.
- [44] H. Murayama and A. Pierce, Phys. Rev. D **65**, 055009 (2002) [arXiv:hep-ph/0108104].
- [45] B. Bajc, P. Fileviez Pérez and G. Senjanović, Phys. Rev. D **66**, 075005 (2002) [arXiv:hep-ph/0204311].
- [46] B. Bajc, P. Fileviez Pérez and G. Senjanović, arXiv:hep-ph/0210374.
- [47] J. R. Ellis and M. K. Gaillard, Phys. Lett. B **88**, 315 (1979).

- [48] M. S. Chanowitz, J. R. Ellis and M. K. Gaillard, Nucl. Phys. B **128**, 506 (1977).
A. J. Buras, J. R. Ellis, M. K. Gaillard and D. V. Nanopoulos, Nucl. Phys. B **135** (1978) 66.
- [49] C. Bachas, C. Fabre and T. Yanagida, Phys. Lett. B **370**, 49 (1996) [arXiv:hep-th/9510094].
- [50] B. Bajc and G. Senjanović, arXiv:hep-ph/0612029.
- [51] B. Bajc, M. Nemevšek and G. Senjanović, arXiv:hep-ph/0703080.
- [52] A. Arhrib, B. Bajc, D. K. Ghosh, T. Han, G. Y. Huang, I. Puljak and G. Senjanović, arXiv:0904.2390 [hep-ph].
- [53] A. Ibarra and G. G. Ross, Phys. Lett. B **591**, 285 (2004) [arXiv:hep-ph/0312138].
- [54] F. R. Joaquim and A. Rossi, Phys. Rev. Lett. **97**, 181801 (2006) [arXiv:hep-ph/0604083].
F. R. Joaquim and A. Rossi, Nucl. Phys. B **765**, 71 (2007) [arXiv:hep-ph/0607298].
- [55] R. N. Mohapatra, *Phys. Rev.* **D 34**, 3457 (1986). A. Font, L. E. Ibáñez and F. Quevedo, *Phys. Lett.* **B228**, 79 (1989). S. P. Martin, *Phys. Rev.* **D46**, 2769 (1992).
- [56] C.S. Aulakh, K. Benakli, G. Senjanović, Phys. Rev. Lett. **79** (1997) 2188. C. S. Aulakh, A. Melfo and G. Senjanović, Phys. Rev. D **57**, 4174 (1998). C. S. Aulakh, A. Melfo, A. Rašin and G. Senjanović, Phys. Rev. D **58**, 115007 (1998) [arXiv:hep-ph/9712551]. C. S. Aulakh, A. Melfo, A. Rašin and G. Senjanović, Phys. Lett. B **459** (1999) 557.
- [57] C. S. Aulakh, B. Bajc, A. Melfo, A. Rašin and G. Senjanović, Nucl. Phys. B **597** (2001) 89.
- [58] B. Bajc, G. Senjanović and F. Vissani, Phys. Rev. Lett. **90** (2003) 051802.
- [59] B. Bajc, G. Senjanović and F. Vissani, Phys. Rev. D **70** (2004) 093002 [arXiv:hep-ph/0402140]. See also B. Bajc, G. Senjanović and F. Vissani, arXiv:hep-ph/0110310.

- [60] For useful reviews on spinors in $SO(2N)$ see R. N. Mohapatra and B. Sakita, Phys. Rev. D **21** (1980) 1062 and F. Wilczek and A. Zee, Phys. Rev. D **25** (1982) 553. See also P. Nath and R. M. Syed, Nucl. Phys. B **618** (2001) 138 and C. S. Aulakh and A. Girdhar, arXiv:hep-ph/0204097.
- [61] K. S. Babu and R. N. Mohapatra, Phys. Rev. Lett. **70**, 2845 (1993).
- [62] E. Witten, Phys. Lett. B **91** (1980) 81.
- [63] B. Bajc and G. Senjanović, Phys. Lett. B **610**, 80 (2005) [arXiv:hep-ph/0411193].
- [64] B. Bajc and G. Senjanović, Phys. Rev. Lett. **95**, 261804 (2005) [arXiv:hep-ph/0507169].
- [65] See e.g. D. Chang, R. N. Mohapatra, J. Gipson, R. E. Marshak and M. K. Parida, Phys. Rev. D **31** (1985) 1718.
- [66] G. Dvali and A. Vilenkin, arXiv:hep-th/0304043. G. Dvali, arXiv:hep-th/0410286.
- [67] B. Bajc, A. Melfo, G. Senjanović and F. Vissani, Phys. Rev. D **73** (2006) 055001 [arXiv:hep-ph/0510139].
- [68] C.S. Aulakh, R.N. Mohapatra, Phys. Rev. D **28** (1983) 217.
- [69] T. E. Clark, T. K. Kuo and N. Nakagawa, Phys. Lett. B **115** (1982) 26.
- [70] D. Chang, R. N. Mohapatra and M. K. Parida, Phys. Rev. D **30** (1984) 1052. X. G. He and S. Meljanac, Phys. Rev. D **41** (1990) 1620. D. G. Lee, Phys. Rev. D **49** (1994) 1417. D. G. Lee and R. N. Mohapatra, Phys. Rev. D **51** (1995) 1353.
- [71] C. S. Aulakh, B. Bajc, A. Melfo, G. Senjanović and F. Vissani, Phys. Lett. B **588**, 196 (2004).
- [72] A. Ferrari *et al.*, Phys. Rev. D **62**, 013001 (2000).
S. N. Gninenko, M. M. Kirsanov, N. V. Krasnikov and V. A. Matveev, Phys. Atom. Nucl. **70**, 441 (2007).
See also a recent talk on the ATLAS study by V. Bansal, arXiv:0910.2215[hep-ex].

- [73] Y. Zhang, H. An, X. Ji and R. N. Mohapatra, Nucl. Phys. B **802**, 247 (2008) [arXiv:0712.4218 [hep-ph]].
- [74] F. Xu, H. An and X. Ji, arXiv:0910.2265 [hep-ph].
- [75] A. G. Akeroyd and M. Aoki, Phys. Rev. D **72**, 035011 (2005) [arXiv:hep-ph/0506176].
 G. Azuelos, K. Benslama and J. Ferland, J. Phys. G **32** (2006) 73 [arXiv:hep-ph/0503096].
 T. Han, B. Mukhopadhyaya, Z. Si and K. Wang, Phys. Rev. D **76**, 075013 (2007) [arXiv:0706.0441 [hep-ph]].
 A. G. Akeroyd, M. Aoki and H. Sugiyama, Phys. Rev. D **77**, 075010 (2008) [arXiv:0712.4019 [hep-ph]].
 P. Fileviez Pérez, T. Han, G. y. Huang, T. Li and K. Wang, Phys. Rev. D **78**, 015018 (2008) [arXiv:0805.3536 [hep-ph]].
- [76] M. Kadastik, M. Raidal and L. Rebane, Phys. Rev. D **77**, 115023 (2008) [arXiv:0712.3912 [hep-ph]].
 J. Garayoa and T. Schwetz, JHEP **0803** (2008) 009 [arXiv:0712.1453 [hep-ph]].
 P. Fileviez Pérez, T. Han, G. Y. Huang, T. Li and K. Wang, Phys. Rev. D **78**, 071301 (2008) [arXiv:0803.3450 [hep-ph]].
- [77] K. Huitu, J. Maalampi, A. Pietila and M. Raidal, Nucl. Phys. B **487**, 27 (1997) [arXiv:hep-ph/9606311].
- [78] K. Inoue, A. Kakuto, H. Komatsu and S. Takeshita, Prog. Theor. Phys. **68** (1982) 927 [Erratum-ibid. **70** (1983) 330].
- [79] L. Alvarez-Gaume, J. Polchinski and M. B. Wise, Nucl. Phys. B **221** (1983) 495.
- [80] P. Nath and P. F. Perez, arXiv:hep-ph/0601023.
- [81] For a review of the seesaw in the context of SO(10), see e.g. G. Senjanović, arXiv:hep-ph/0501244.
- [82] I. Dorsner and P. F. Perez, Nucl. Phys. B **723** (2005) 53 [arXiv:hep-ph/0504276].
- [83] B. Bajc, A. Melfo, G. Senjanović and F. Vissani, Phys. Rev. D **70** (2004) 035007.

- [84] T. Fukuyama, A. Ilakovac, T. Kikuchi, S. Meljanac and N. Okada, arXiv:hep-ph/0401213. C. S. Aulakh and A. Girdhar, arXiv:hep-ph/0204097.
- [85] C. S. Aulakh and A. Girdhar, arXiv:hep-ph/0405074.
- [86] H. S. Goh, R. N. Mohapatra and S. Nasri, arXiv:hep-ph/0408139.
- [87] K. S. Babu and C. Macesanu, Phys. Rev. D **72** (2005) 115003 [arXiv:hep-ph/0505200]. S. Bertolini, M. Frigerio and M. Malinsky, Phys. Rev. D **70**, 095002 (2004) [arXiv:hep-ph/0406117].
- [88] H. Arason, D. J. Castano, E. J. Piard and P. Ramond, Phys. Rev. D **47** (1993) 232 [arXiv:hep-ph/9204225].